

ISSI

INNOVATIVE SCIENTIFIC SOLUTIONS, INC

**Innovative Scientific
Solutions, Inc.**

innssi.com

PRODUCT CATALOG

2020



TABLE OF CONTENTS

1 PRESSURE SENSITIVE PAINT	3
1.1 SINGLE LUMINOPHORE PRESSURE SENSITIVE PAINT	8
1.2 BINARY PRESSURE SENSITIVE PAINT	10
1.3 FAST PRESSURE SENSITIVE PAINT	13
1.4 TEMPERATURE SENSITIVE PAINTS	18
1.5 BASE COATINGS	20
1.6 PAINT STARTER KIT	22
2 LED LIGHT SOURCES	23
2.1 AIR-COOLED	24
2.2 WATER-COOLED	28
2.3 VORTEX-COOLED LEDs	31
2.4 SPECIAL APPLICATIONS	33
2.5 LED ACCESSORIES	38
3 CAMERAS	41
3.1 CCD CAMERAS	42
4 SYSTEM INTEGRATION	46
4.1 PULSE/DELAY GENERATOR	47
4.2 CCTV LENS CONTROLLER	48
4.3 CCTV LENS CONTROLLER **NEW PRODUCT**	49
4.4 CANON® EF/EF-S LENS CONTROLLER	50
4.5 PSP/TSP CALIBRATION SYSTEM	52
4.6 PSP/TSP OPTICS	53
5 MOLECULAR IODINE CELLS	54
5.1 PERMANENTLY SEALED MOLECULAR IODINE CELL	55
5.2 MANIFOLD MOLECULAR IODINE CELL	56
6 SOFTWARE	57
6.1 PROACQUIRE PSP/TSP ACQUISITION SOFTWARE	57
6.2 OMS-LITE BEGINNER PSP/TSP POST-PROCESSING SOFTWARE	58
6.3 OMS-PROIMAGE ADVANCED PSP/TSP POST-PROCESSING SOFTWARE	59
7 PACKAGED SYSTEMS	60
6.1 SMALL-SCALE ACADEMIC PSP/TSP SYSTEMS	60
6.2 LARGE-SCALE COMMERCIAL PSP/TSP SYSTEMS	61
8 SURFACE STRESS SENSITIVE FILM	63
8.1 MINIATURE S3F SENSOR SYSTEM	64
8.2 INTERMEDIATE S3F SENSOR SYSTEM	65
8.3 FOOTSTEPS GAIT ANALYSIS SENSOR SYSTEM	66
9 ORDERING	67

ABOUT ISSI

Founded in 1995, Innovative Scientific Solutions Incorporated (ISSI) is an engineering research and development company providing innovative measurement and instrumentation solutions in the areas of Fluid Dynamics, Aerodynamics, Combustion Analysis, Pressure Sensitive Paint, Temperature Sensitive Paint, Shear Stress Sensors, timing and control devices and lens control products.

ISSI supports the US Dept. of Defense, NASA, National Institutes of Health, and other federal customers, as well as U.S. industry and academic laboratories. We work with government and industry laboratories in Europe, Asia, and South America, as well as academic organizations worldwide.



ISSI is located in Dayton, Ohio, USA, home of Wright-Patterson Air Force Base.

Innovative Scientific Solutions Incorporated

7610 McEwen Road
Dayton, OH, USA 45459-3908
Tel: (937) 630-3012
Fax: (937) 630-3015

Export Policy

ISSI maintains a comprehensive export program in accordance with U.S. export law. Sales outside the U.S. may require an export license depending on country and end use application. The requirement of an export license is not a guarantee that a license will be granted by the U.S. government.

Disclaimer

Any and all underlying information and technology contained in this document may be subject to U.S. export controls, including the Export Administration Act (50 U.S.C. 56 §§ 4601-4623) and the Export Administration Regulations ("EAR", 15 CFR Parts 730-774) and may be subject to export or import regulations in other countries. You are responsible for complying with all trade regulations and laws both foreign and domestic. Except as authorized by law or distributor agreement with ISSI, you agree and warrant not to export or re-export this information to any country, or to any person, entity, or end-user subject to U.S. export controls, including without limitation persons or entities listed on the U.S. Department of Commerce Bureau of Industry and Security's Entity List, Denied Person List, and Unverified List and the U.S. Department of Treasury's Specially Designated Nationals. You further represent and warrant that no U.S. federal agency has suspended, revoked, or denied your export privileges.

Sales outside of the United States may require an export license. Export license determination is dependent on the end use of the item(s), the location of the end user(s) and the end user(s) themselves. All sales are subject to US Export law.

For questions about the ISSI export compliance policies, contact the Empowered Official, Mr. Steve Palluconi (spalluconi@innssi.com) or the Export compliance officer, Mr. Grant McMillan (gmcmillan@innssi.com). For further information, please see ISSI's Terms and Conditions.

1| Pressure Sensitive Paint

BACKGROUND

Pressure sensitive paints (PSP) are optical sensors for surface pressure measurements. Traditional techniques for measuring surface pressure on models are limited to point measurements and to geometries where there is enough space to install them. Installation and instrumentation of a model with pressure taps and transducers is often costly due to the machining requirements and the sensors themselves. PSP is not limited by model geometry. It can measure pressure on model surfaces at every visible point with superior spatial resolution. Much like a paint coating, PSP is applied to a surface using an HVLP paint gun or airbrush.

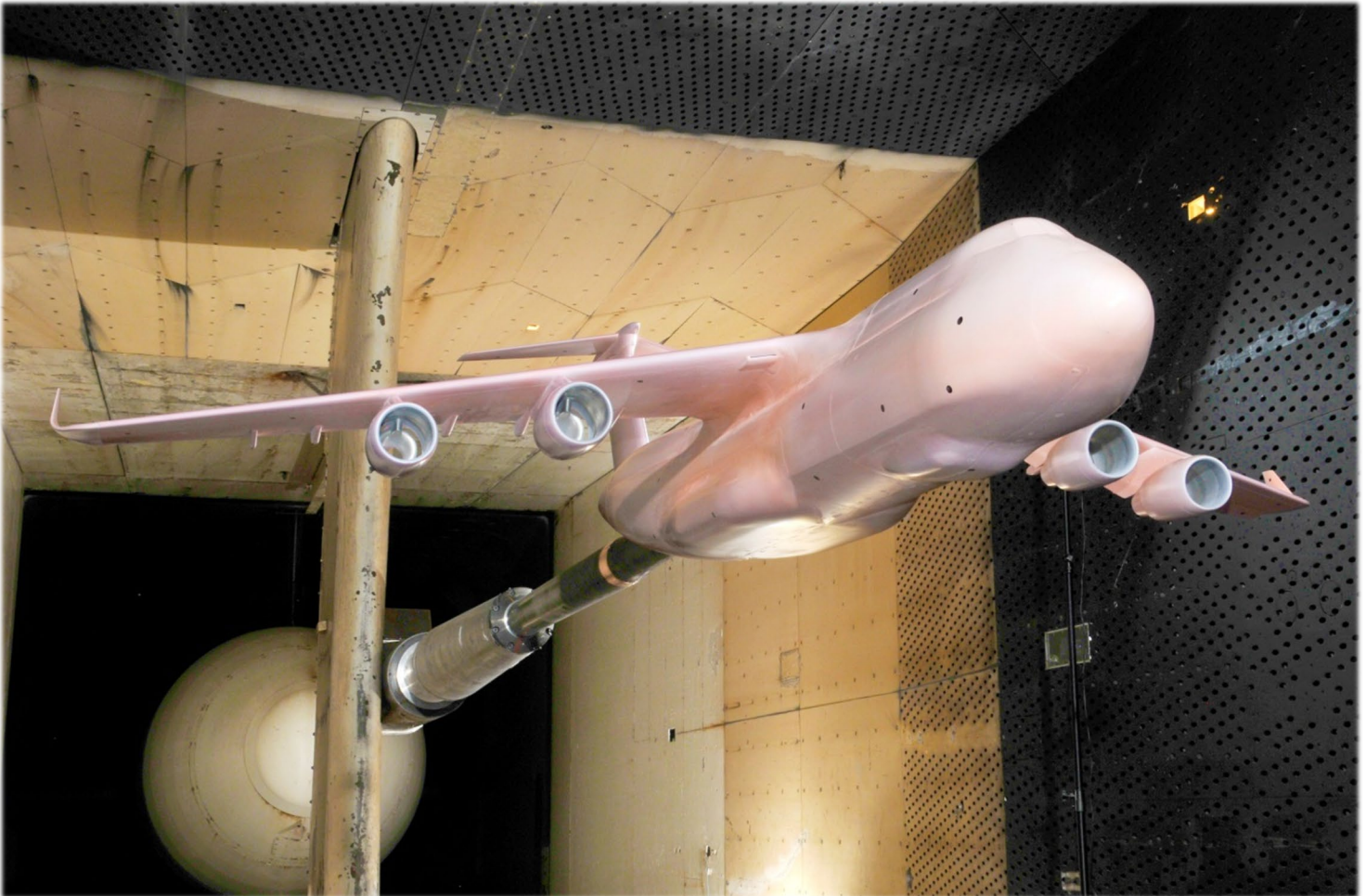

A C-5M Super Galaxy Model Painted with Pressure Sensitive Paint (U.S. Air Force Photo)

Most often, PSP is used in wind tunnel research as a validation tool for computational fluid dynamics (CFD) models of certain flow conditions over a model of an aircraft. Wind tunnels from small, academic low-speed wind tunnels to large scale transonic research wind tunnels and hypersonic wind tunnels have utilized PSP for model testing and validation for over 20 years. Today, PSP continues to be a valuable resource in government and commercial testing of aircraft, helicopter, automotive, high-speed train, bridge and architectural models and their components. PSP is also utilized as a tool for film-cooling effectiveness measurements in gas turbine engine blade design.

How Does PSP Work?

A typical PSP is composed of an oxygen-sensitive fluorescent molecule embedded in an oxygen permeable binder. The PSP method is based on the sensitivity of certain luminescent molecules to the presence of oxygen. After application, the PSP is excited with a high-intensity LED, typically a UV 400-nm source. When a luminescent molecule within the PSP absorbs a photon from the LED, it transitions to an excited singlet energy state. The molecule then recovers to the ground state by the emission of a photon of a longer wavelength (red-shifted). When oxygen can interact with the molecule, the transition to the ground state is non-radiative. This process is known as oxygen quenching. The rate at which these two processes compete is dependent on the partial pressure of oxygen at the PSP surface. A higher oxygen quenching rate results in a lower intensity of light emitted from the PSP layer. Conversely, a lower oxygen quenching rate results in a higher intensity of light emitted. The result is an output from a model surface of varying intensities based on the local oxygen concentration which is directly correlated to the local barometric pressure. The output from the PSP is recorded with a sensitive scientific camera through a long-pass filter which separates the LED excitation from the PSP emission.

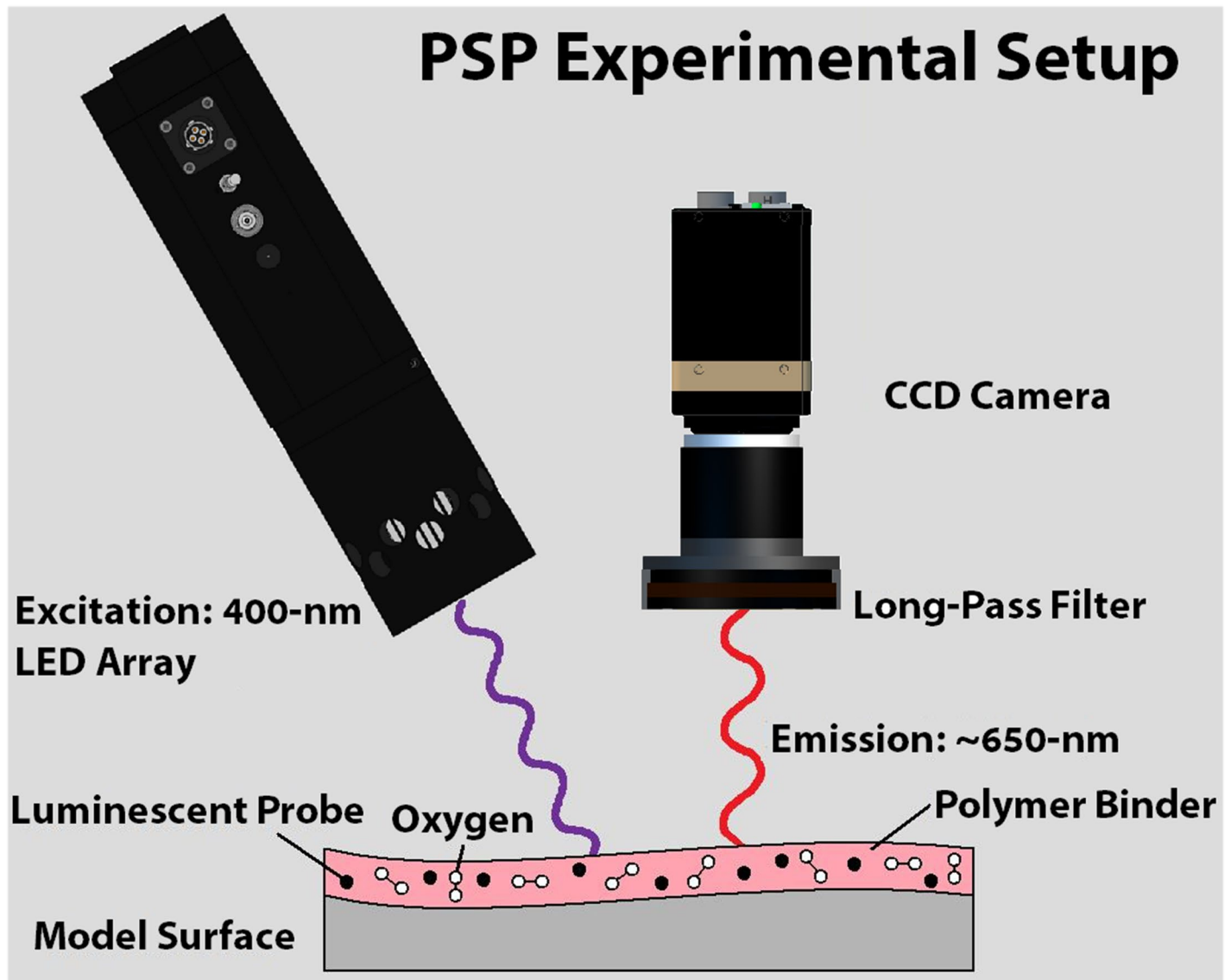

After the images are captured with the camera, they are stored for post-processing. Images are converted from images of intensity variations to images of pressure using a previously determined calibration of the same paint type. From there, false color maps are applied to better visualize the pressure gradients on the model surface. Data can be plotted and compared to pressure taps if present. Typical PSP test are within 5% of the pressure tap data.

PSP Tests

So, what can PSP do for you? PSP is utilized anywhere from small academic wind tunnels to large-scale commercial and government test facilities to deliver high-resolution pressure measurements for CFD comparison, loads calculations and model validation.

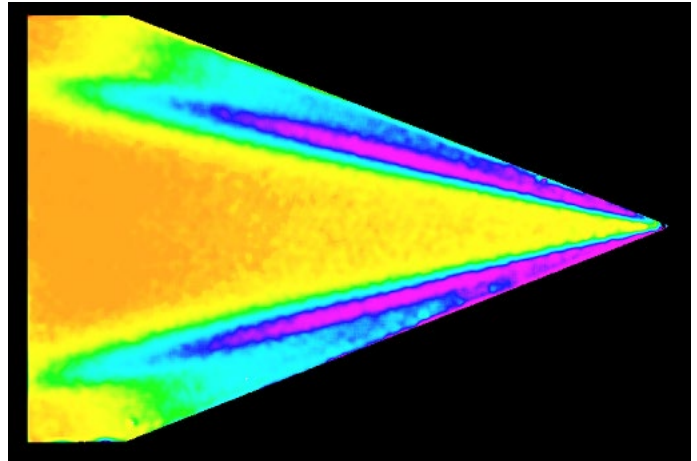
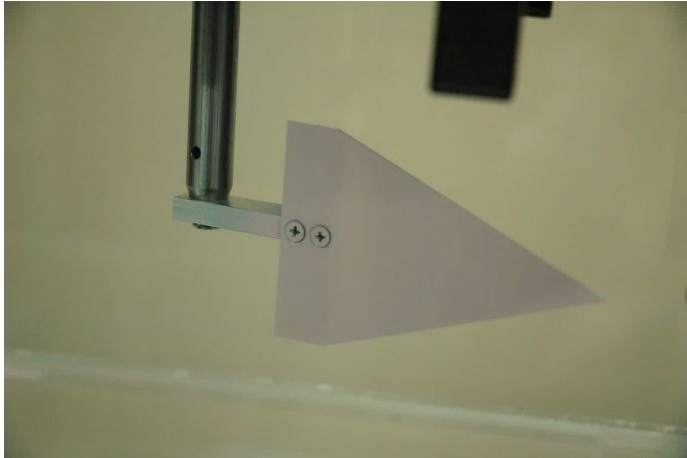

Delta Wing Painted with PSP (Left), PSP Data After Post-Processing (Right)

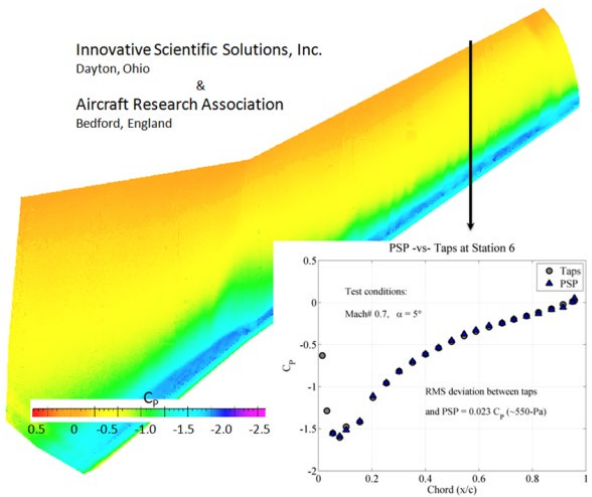
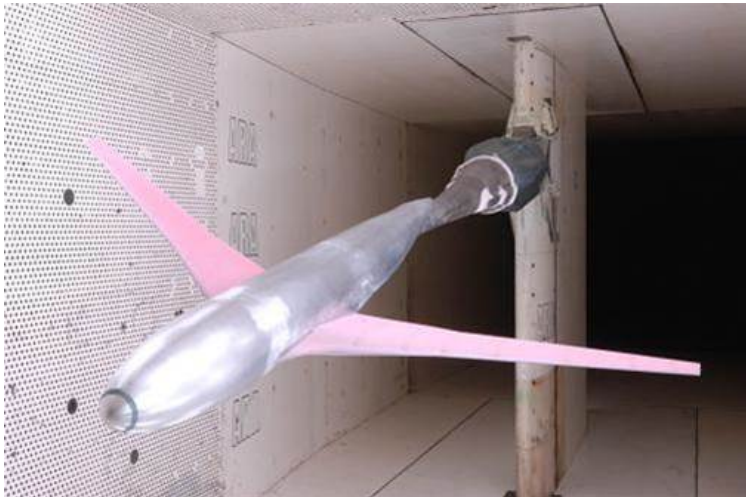

Wind Tunnel Model Painted with PSP at ARA's Transonic Wind Tunnel (Left), PSP Data Compared to Pressure Taps (Right)

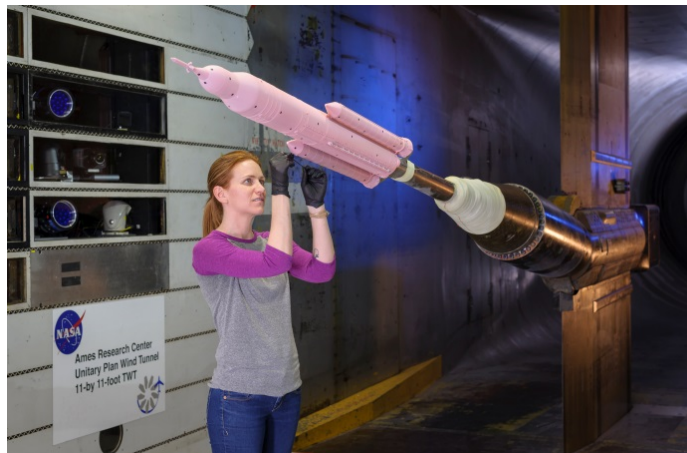

Preparation of SLS Rocket Model (Left), SLS Rocket Model Glowing Pink Under UV LEDs (Credit: D. Hart / NASA Ames Research Center)

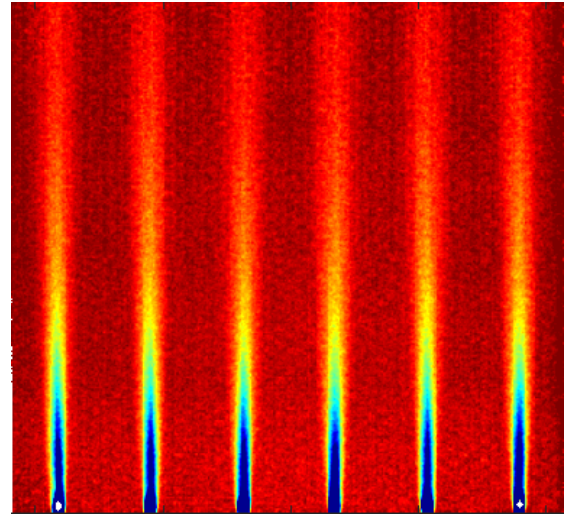
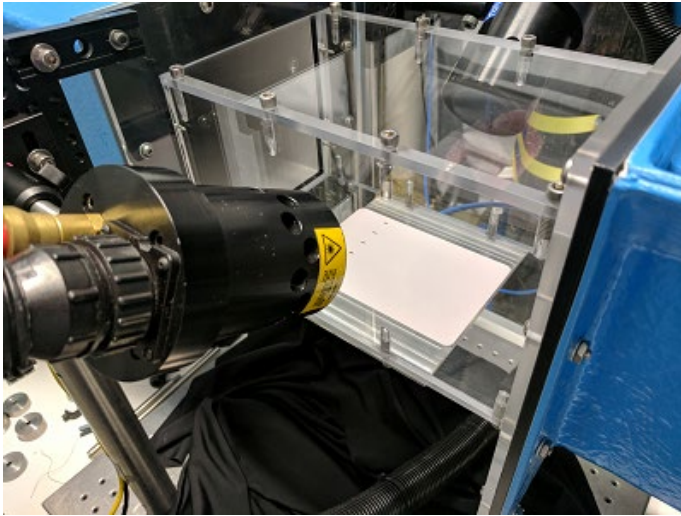

Film Cooling PSP Setup in Small Wind Tunnel (Left), Film Cooling PSP Results (Right)

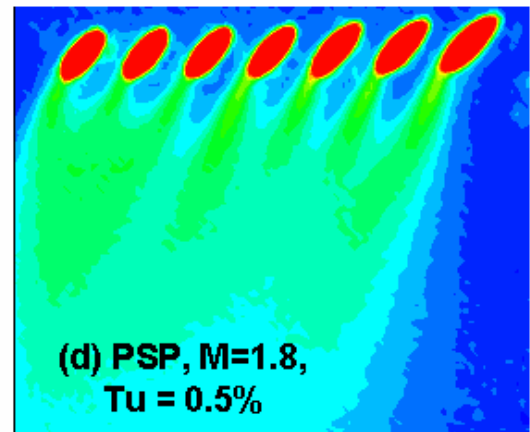
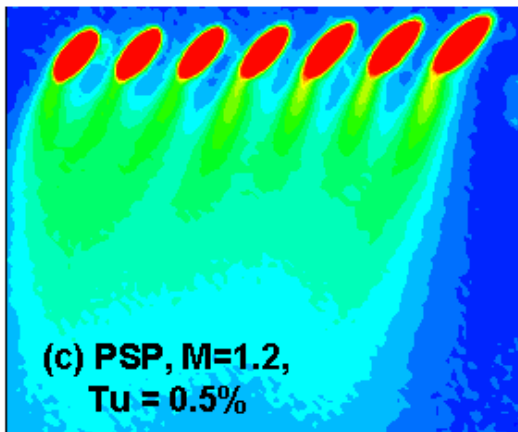
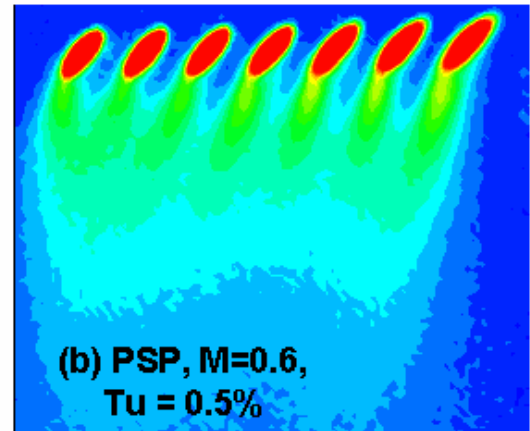
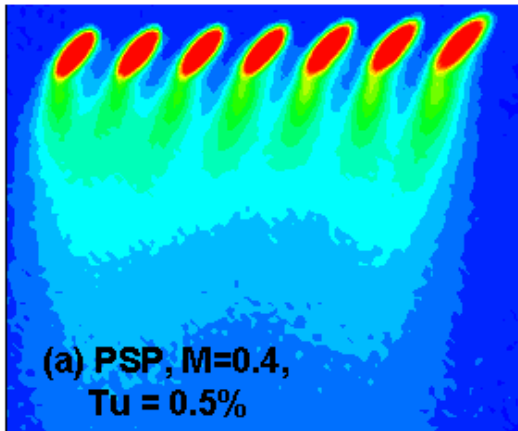

Film cooling effectiveness measurements from traditional gas analysis systems compare very well with measurements obtained using ISSI's fluorescent film cooling system. Data Courtesy of Wright & Hahn, Texas A&M

Paint Quantities

Pressure sensitive paints come in a variety of quantities. Standard quantities are 200-, 400-, and 750-ml.



Paints ship in glass jars for application with pneumatic painting guns. Academic paints are available in aerosol spray cans for easy application.



1.1 | Single-Luminophore Pressure Sensitive Paint

UNICOAT™ PRESSURE SENSITIVE PAINT

(Product ID: UNC-12)

UniCoat is a single-luminophore pressure sensitive paint (PSP) packaged in an aerosol can for ease of application. UniCoat has slightly higher temperature sensitivity and slightly lower pressure sensitivity than UniFIB PSP, but is a simple shake and spray application at a lower cost than other products and is ideal for academic purposes. This single coat application paint may be applied directly to most materials. UniCoat is an effective quantitative PSP well suited for isothermal environments (large metal models and temperature-controlled tunnels) or where strong pressure variations are present (transonic and supersonic flows). UniCoat is recommended for introductory PSP users who seek an inexpensive paint for the purpose of developing their PSP capabilities.

Nitrogen Jet Impinging on UniCoat PSP

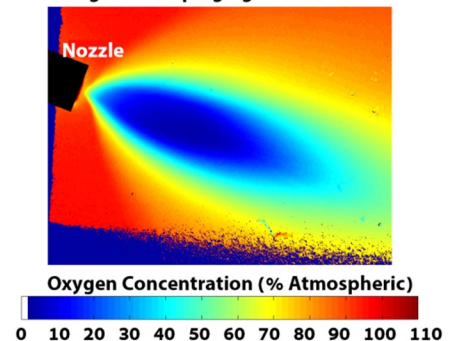

SPECIFICATIONS

Pressure sensitivity	0.5% per kPa
Pressure range	1-kPa to 200-kPa
Temperature sensitivity	1.3% per °C
Temperature range	-10°C to 60°C
Response time	750 ms
Excitation	380-nm to 520-nm (400-nm ideal)
Emission	620-nm to 750-nm
Photo-degradation rate	1% per hour (Excitation)
Shelf life	12-months
Filter	610-nm
ECCN	EAR99

Available Quantities: 12-oz aerosol spray can

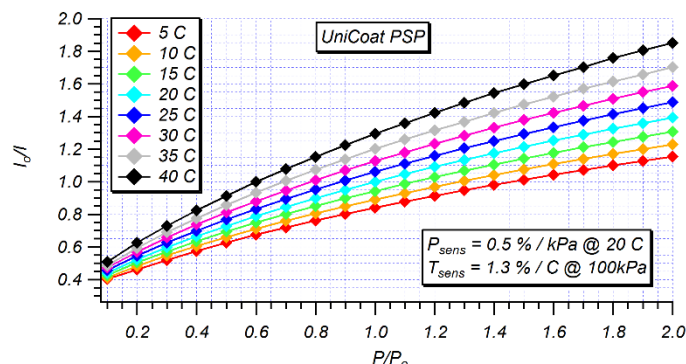

Calibration

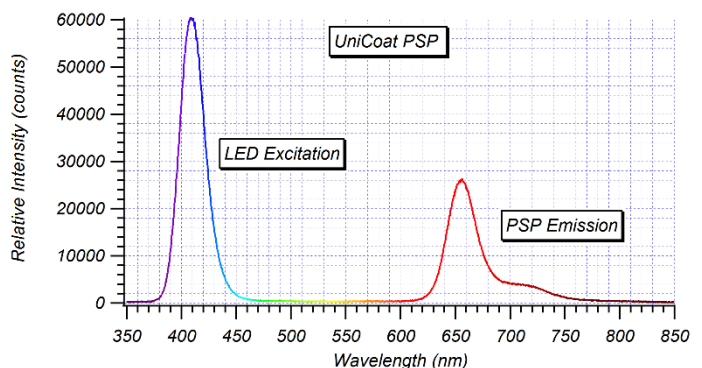

Spectral Response

UniFIB® Pressure Sensitive Paint

(Product ID: UF-XXX)

UniFIB® is a bright single-luminophore pressure sensitive paint (PSP) formulated to be applied with paint spraying equipment as a single component PSP optimized for maximum luminescent signal while maintaining high pressure sensitivity and low temperature sensitivity. This paint formulation may be excited effectively from 370-nm to 520-nm, however, 400-nm radiation from ISSI LED modules is recommended. The paint may be applied to most materials, though models constructed of materials that may be attacked by solvents, such as plastic or rapid prototyping resins, should be coated with a base coat such as SCR-100 (Screen layer) or FB (FIB basecoat). The calibration of UniFIB® is very stable and repeatable thus UniFIB® is recommended for advanced/professional PSP users who seek high-quality data up to transonic flow conditions.

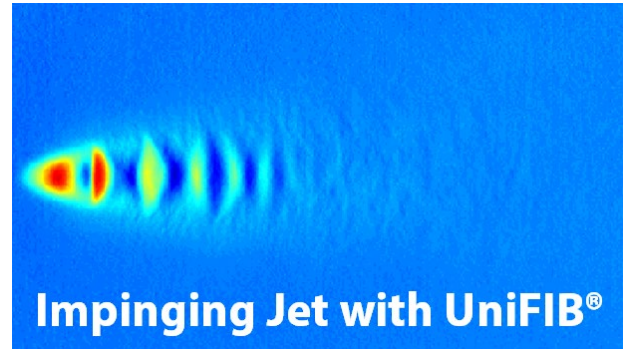

SPECIFICATIONS

Pressure sensitivity	0.8% per kPa
Pressure range	0-kPa to 200-kPa
Temperature sensitivity	0.4% per °C
Temperature range	0°C to 50°C
Response time	300 ms
Excitation	380-nm to 520-nm (400-nm ideal)
Emission	620-nm to 750-nm
Photo-degradation rate	1% per hour (Excitation)
Shelf life	12-months
Filter	610-nm
ECCN	EAR99

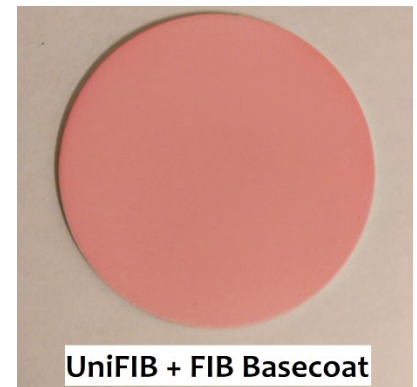

Available quantities: 200-, 400-, 750-ml

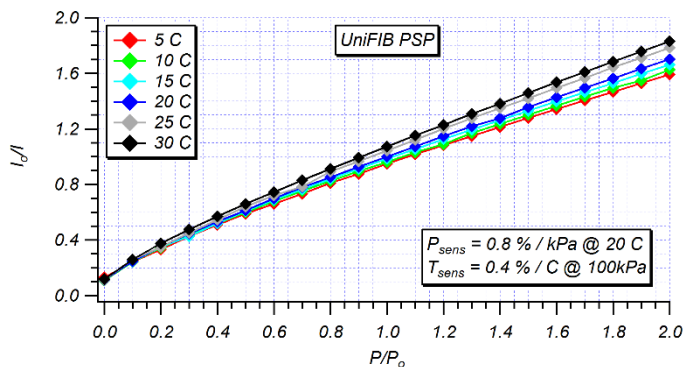

Calibration

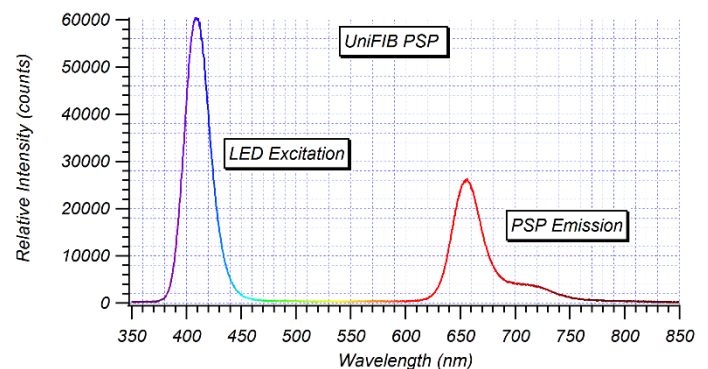

Spectral Response

1.2 | Binary Pressure Sensitive Paint

Major sources of error in PSP data are due to illumination variations and temperature changes during the data collection period while the wind tunnel is running. Blow-down type wind tunnels will change temperature during the course of a run while closed-circuit or continuous wind tunnels are more stable with temperature. Errors in pressure measurements taken at low wind speeds are largely the result of temperature gradients on the model surface. These temperature gradients can be the result of model construction, tunnel operation, or fluid dynamics. A rapid prototype model, for example, is constructed using an internal metal structure and a polymer resin. The thermal signature of the internal structure is apparent when the surface of the model is subjected to a heat flux. The model is exposed to a heat flux due to changes in tunnel Mach number. This condition is most apparent during tunnel startup. Temperature errors can be minimized by using temperature-controlled tunnels and constructing the model from materials with high thermal conductivity like aluminum or stainless steel. Model construction and tunnel operation are key considerations for effective low-speed PSP measurements. Illumination variations can be caused by non-stable output from LEDs and by vibrations of the model or camera relative to one another. To the camera, these changes are interpreted as pressure changes.

A way of dealing with the temperature errors is to add a second component to the PSP. This is known as Binary PSP. What Binary PSP adds that single-component PSP lacks is the ability to correct for temperature and illumination induced errors. Binary PSP works by acquiring data from both the oxygen sensitive component and the second component, known as the reference molecule. The emission from the reference and oxygen sensitive molecules are spectrally independent. A color camera is used to separate the signals from the reference and oxygen sensitive components of the Binary PSP. From this, two images are acquired (one of the reference and one of the oxygen sensitive component). Taking the ratio of the oxygen sensitive image over the reference image eliminates dependence on temperature. This is due to the reference and oxygen sensitive molecules having the same sensitivity to temperature. By dropping the temperature dependence, an ideal PSP is created where the only dependence is on the pressure change.

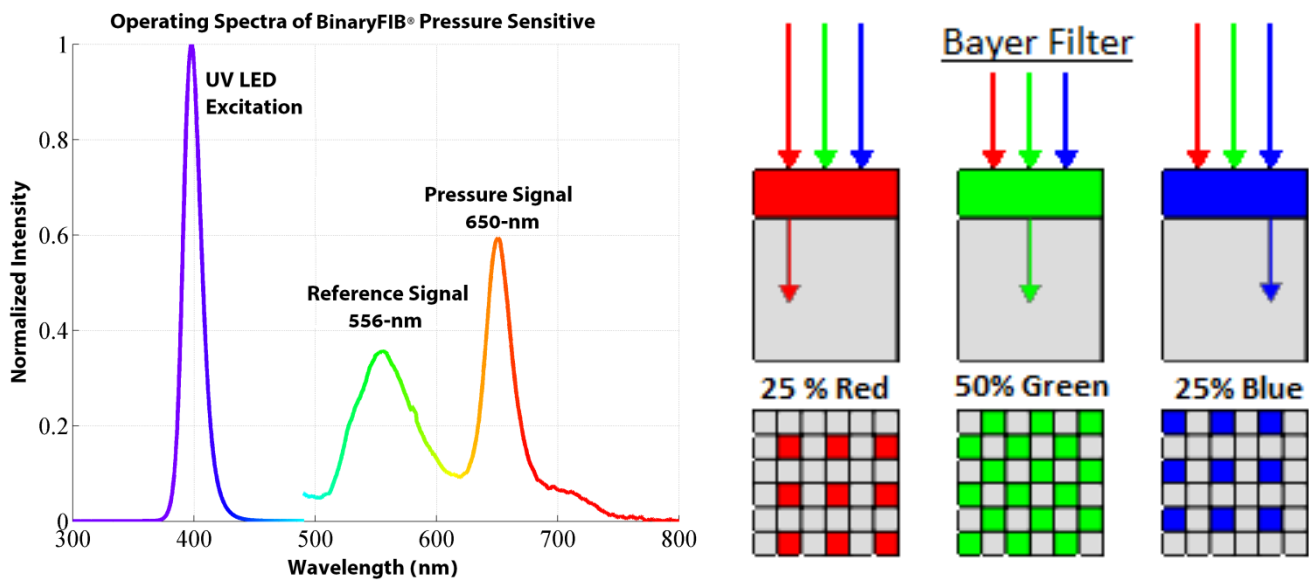

Emission from Binary PSP (Left), Color Separation on a Color CCD Camera Sensor (Right)

Where temperature changes during the data acquisition are not a problem, single-component PSPs are still used. Higher resolution images can be obtained using single-component PSPs as they use a monochrome camera and don't reduce the resolution like a color camera does when it separates colors.

BINARY UNICOAT PRESSURE SENSITIVE PAINT

(Product ID: BUNC-12)

Binary UniCoat is a dual-luminophore pressure sensitive paint (PSP) packaged in an aerosol can for ease of application. The binary PSP approach involves acquiring data from two distinct luminescent dyes and using these signals to compensate for errors caused by model displacement and deformation. Binary UniCoat has higher temperature sensitivity and lower pressure sensitivity than FIB-based paints as shown in the calibration below. A desirable feature of Binary UniCoat is ease of application. Simply shake the can and spray the surface. The result is a single coat application paint that may be applied directly to most materials. Binary UniCoat is an effective quantitative PSP in isothermal environments (large metal models and temperature controlled tunnels) or where strong pressure variations are present (transonic flows). It is also effective in compensating for errors due to model displacement and deformation. Binary UniCoat is recommended for introductory PSP users who seek an inexpensive means to gain experience with binary paints.

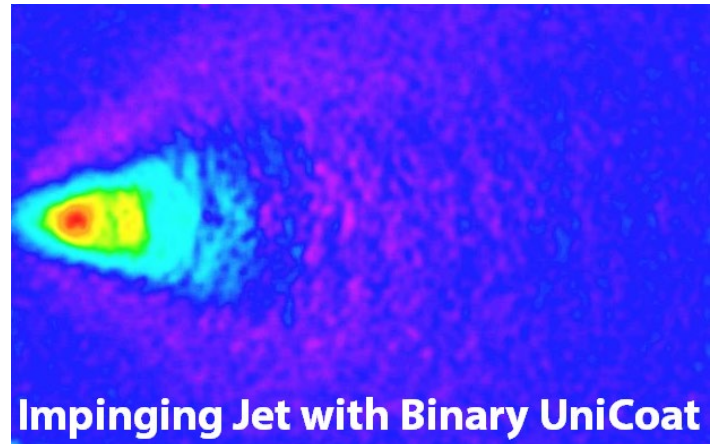

SPECIFICATIONS

Pressure sensitivity	0.5% per kPa
Pressure range	1-kPa to 200-kPa
Temperature sensitivity	0.9% per °C
Temperature range	-10°C to 60°C
Response time	750 ms
Excitation	380-nm to 520-nm (400-nm ideal)
Emission	500-nm to 750-nm
Photo-degradation rate	1% per hour (Excitation)
Shelf life	12-months
Filter	495-nm
ECCN	EAR99



Available Quantities: 12-oz aerosol spray can

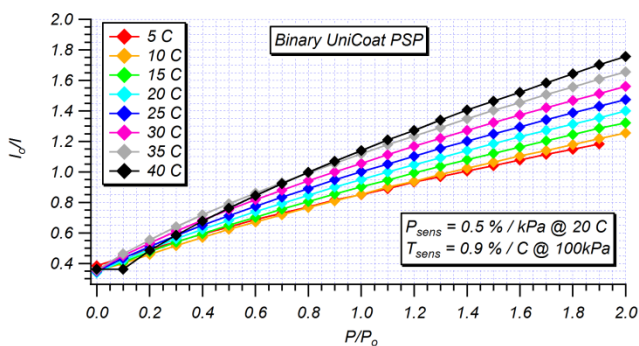

Calibration

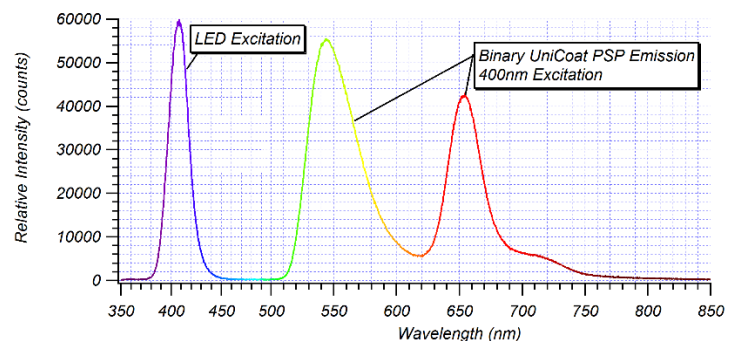

Spectral Response (PSP Emission Scaled)

BINARYFIB® PRESSURE SENSITIVE PAINT

(Product ID: BF-XXX)

BinaryFIB® pressure sensitive paint (PSP) is a dual-luminophore, single application PSP formulated to be applied with paint spraying equipment. The binary paint approach involves acquiring data from two distinct luminescent dyes and using these signals to compensate for errors caused by model displacement and deformation as well as temperature. One dye is pressure and temperature sensitive and the other dye is temperature sensitive only. The ratio of the signals from the two dyes allows the temperature sensitive signal to be isolated from the pressure sensitive signal. The temperature sensitivity of the paint can be minimized over a wide range of temperatures and pressures as shown in the calibration below. The paint may be applied to most materials, however a white base coat such as SCR-XXX (Screen layer) or FB-XXX (FIB basecoat) is recommended. Models constructed of materials that may be attacked by solvents such as plastic or rapid prototyping resin should be coated with a screen layer or FIB basecoat. The calibration of BinaryFIB® is very stable, repeatable, and exhibits very little temperature sensitivity. BinaryFIB® is recommended for advanced/professional PSP users who seek high quality data in low-speed environments or where temperature gradients are larger and have a greater impact on the signal-to noise ratio.

BinaryFIB® on Aircraft Wing in Transonic Wind Tunnel

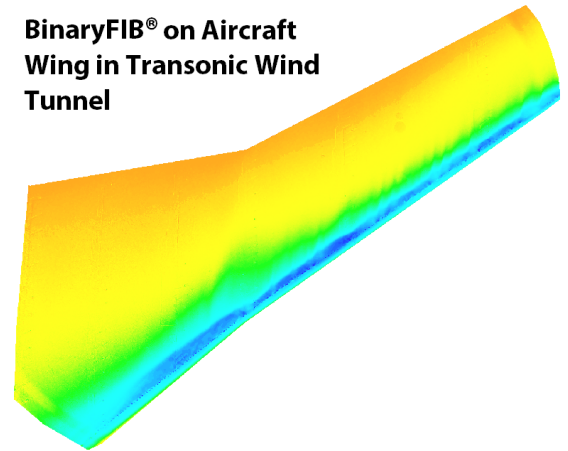

SPECIFICATIONS

Pressure sensitivity	0.6% per kPa
Pressure range	0-kPa to 200-kPa
Temperature sensitivity	0.03% per °C
Temperature range	0°C to 50°C
Response time	300 ms
Excitation	380-nm to 420-nm (400-nm ideal)
Emission	500-nm to 720-nm
Photo-degradation rate	1% per hour (Excitation)
Shelf life	12-months
Filter	530-nm
ECCN	EAR99



Available quantities: 200-, 400-, 750-ml

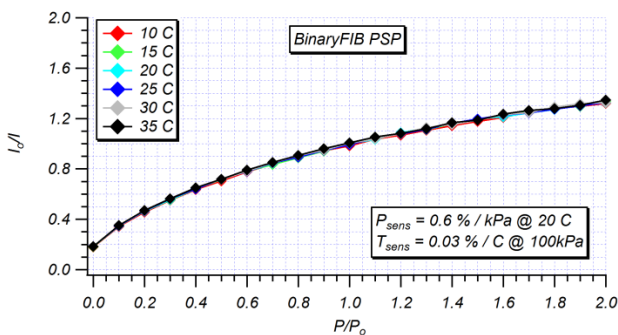

Calibration

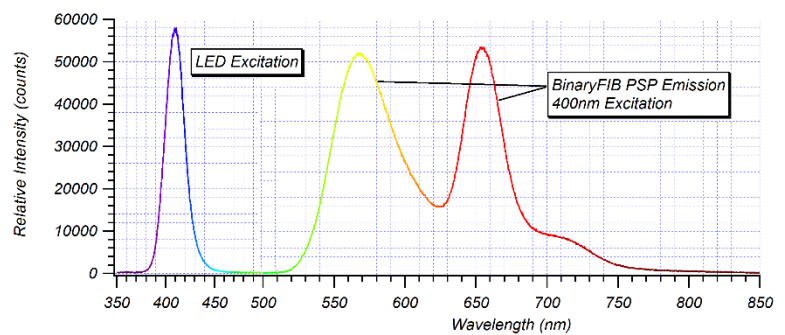

Spectral Response (PSP Emission Scaled)

1.3 | Fast Pressure Sensitive Paint

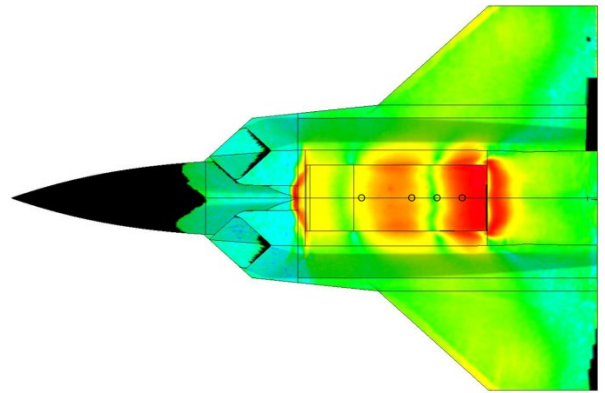
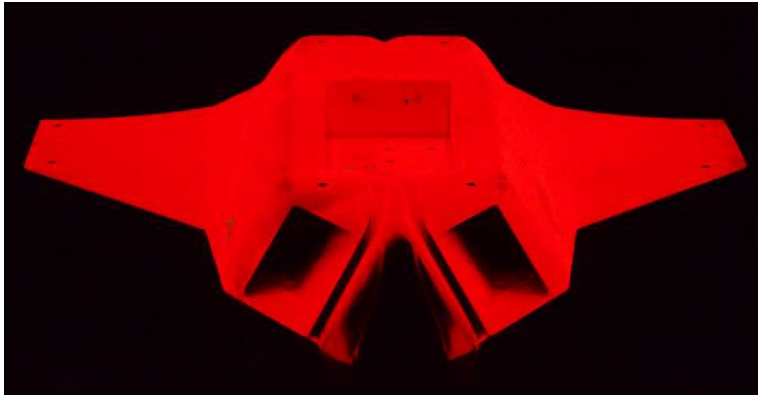

Fast PSP on an Air Force 1/15th Scale Model of an Advanced Tactical Fighter (U.S. Air Force Photo)

Conventional polymer-based paint formulations have response times on the order of ~1 second, making them unsuitable for evaluating unsteady aerodynamic phenomena. The temporal-response characteristics of PSP are primarily governed by the thickness of the paint formulation and the diffusion coefficient of the binder material. The response time due to diffusion (τ_{diff}) increases with the paint thickness (h) squared and decreases with increasing diffusion coefficient (D_m).

$$\frac{\partial[O_2]}{\partial t} = D_m \frac{\partial^2[O_2]}{\partial z^2}$$

$$\tau \propto h^2 / D_m$$

Some fast responding paints have focused on decreasing the thickness of the paint in order to improve the temporal response characteristics. This approach sacrifices luminescent output from the paint, and thus the signal-to-noise ratio, for a faster response time and a lower signal-to-noise ratio. Porous binders have been developed with the goal of enhancing the oxygen diffusion within the paint layer and, thus, improving the temporal response without reducing the signal-to-noise ratio.

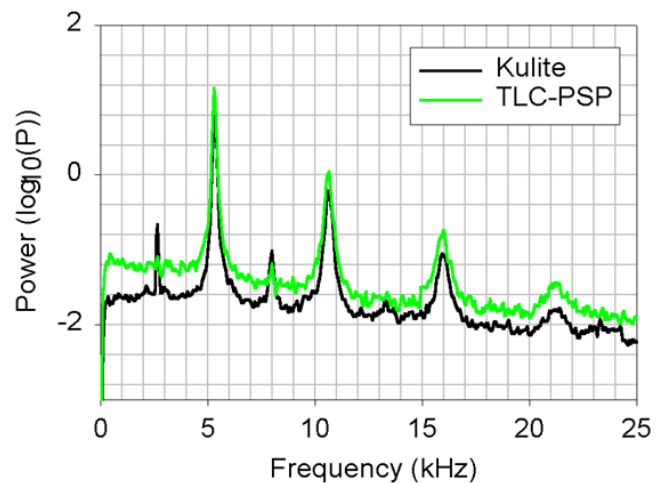
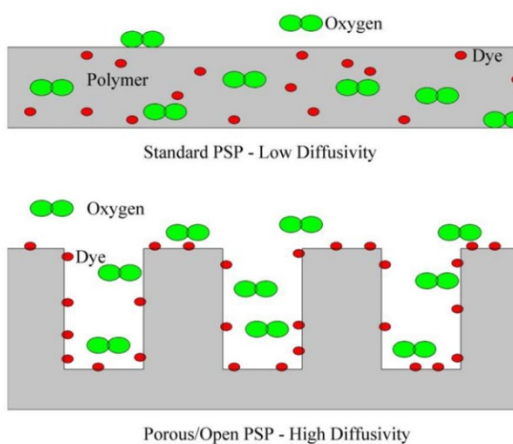

ISSI's Porous, Fast PSP is an example of this type of PSP structure, exhibiting good pressure sensitivity (more than 0.6%/kPa), strong signal and excellent temporal response of 20-kHz. The paint may be applied to clean, dry, materials such as Aluminum, Glass, Plastic, or Steel, and no base coat or heat treating is required. Porous, Fast PSP is recommended for applications that require a bright paint with frequency response of up to 20-kHz.

Fast PSP Tests

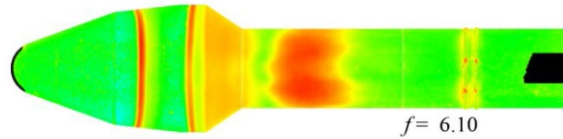
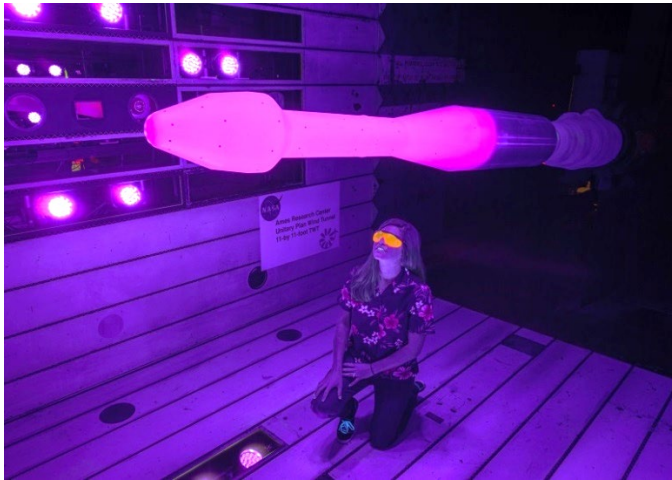

Fast PSP Under UV Excitation on a Space Launch Vehicle Model (Left), Processed Unsteady Pressure Fluctuations from Buffeting at 6.10 Hz (Right), (Credit: D. Hart / NASA Ames Research Center)

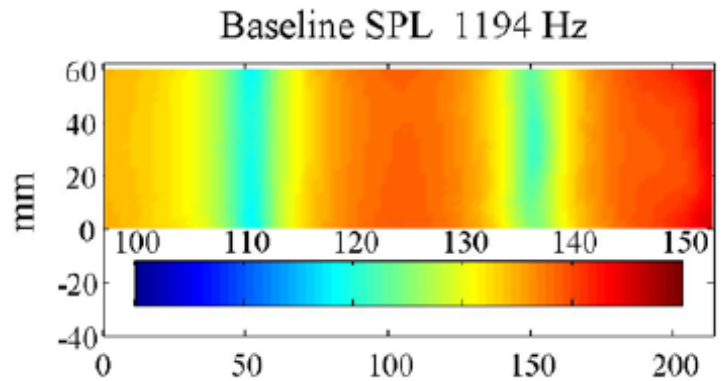

Fast PSP in a Subsonic Cavity Under UV Excitation (Left), Standing Pressure Waves in a Subsonic Cavity (Right), (Courtesy: US Air Force)

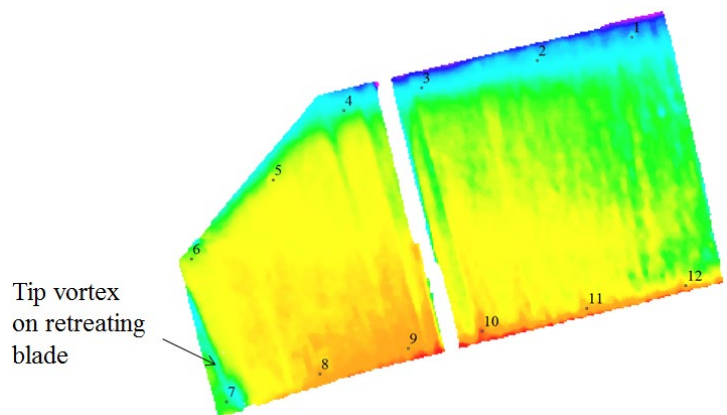
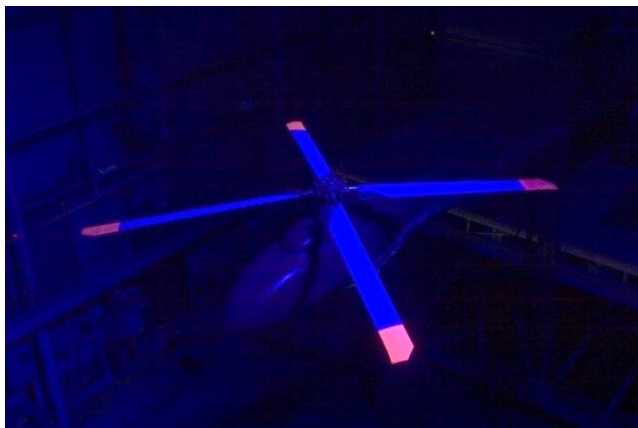

Fast PSP Test of U.S. Army Rotorcraft Model Looking at Pressure Distribution on Blade Tip (Image Credit: NASA/David C. Bowman)

TURBOFIB® PRESSURE SENSITIVE PAINT

(Product ID: TF-XXX)

TurboFIB® pressure sensitive paint (PSP) is a single-luminophore, single application PSP formulated to be applied with paint spraying equipment. TurboFIB® provides many of the advantages of UNIFIB PSP, but with faster response (1 kHz) and reduced temperature sensitivity. This paint formulation may be excited effectively from 380-nm to 550-nm, however, 400-nm radiation from LM2X-DM-400 LED modules is recommended. The paint may be applied to most surfaces, though it is recommended that plastics and rapid prototyping resins first be coated with SCR-XXX (Screen layer) to protect the surface from solvent damage. The calibration of TurboFIB® (shown below) is very stable and repeatable thus TurboFIB® is recommended for advanced/professional PSP users who seek high quality data. Paint is sold in quantities of 200-ml, 400-ml and 750-ml. Custom quantities are available upon request. Surface coverage is approximately 1 m² per liter.

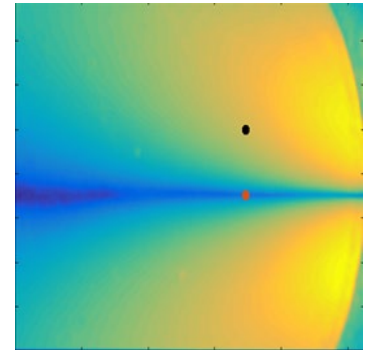

SPECIFICATIONS

Pressure sensitivity	0.8% per kPa
Pressure range	0-kPa to 200-kPa
Temperature sensitivity	0.4% per °C
Temperature range	0°C to 50°C
Response time	<1 ms
Excitation	380-nm to 550-nm (400-nm ideal)
Emission	620-nm to 750-nm
Photo-degradation rate	1% per hour (Excitation)
Shelf life	12-months
Filter	610-nm
ECCN	EAR99

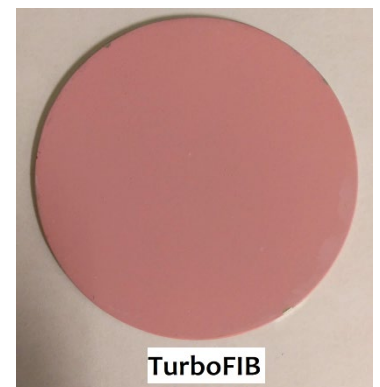

Available quantities: 200-, 400-, 750-ml

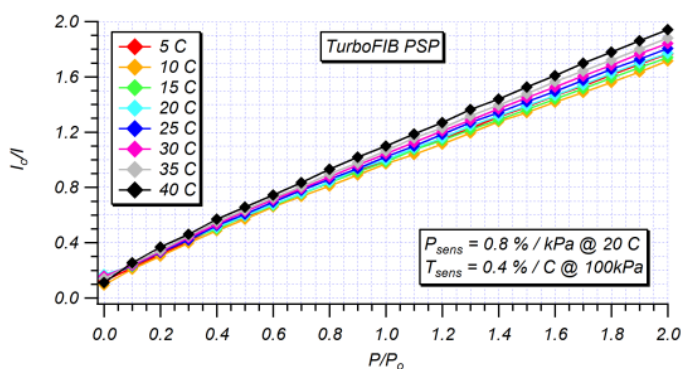

Calibration

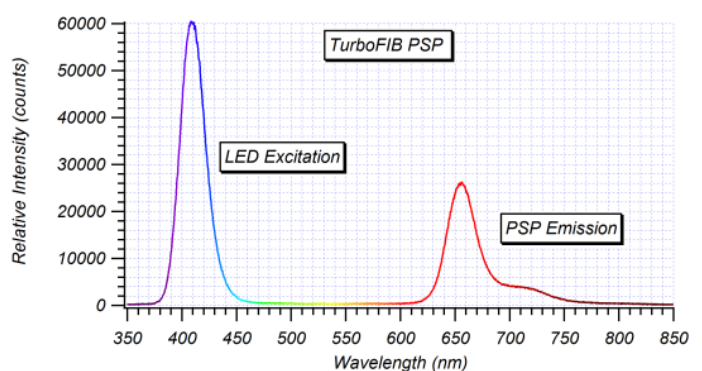

Spectral Response

POROUS, FAST-RESPONSE PRESSURE SENSITIVE PAINT

(Product ID: FP-XXX)

Porous Fast-Response PSP is a three component, single-luminophore high speed pressure sensitive paint (PSP) formulated to provide high speed response (>10kHz) suitable for unsteady pressure measurements with high pressure sensitivity. The temperature sensitivity of these paints is higher than UniFIB® or TurboFIB® so this PSP is best suited for isothermal environments. This paint comes in three parts. Determine how much PSP you need for your application and measure out part A by volume. Part B will be measured out 5% by volume of part A. Shake the part A and B mixture well. This mixture is to be sprayed with paint spraying equipment on to the surface of study with a wet application to achieve a smooth finish. This application is the base layer. Once the base layer is dry, apply part C with paint spraying equipment, the overspray. The overspray, part C, may be reapplied more than once. A typical order would be a 100mL kit which would consist of three containers: 100 mL of part A, 5 mL of part B, and 100mL of part C.

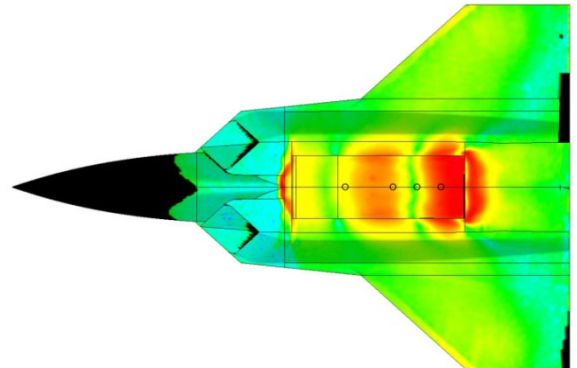

SPECIFICATIONS

Pressure sensitivity	0.6% per kPa
Pressure range	0-kPa to 200-kPa
Temperature sensitivity	3.6% per °C
Temperature range	0°C to 80°C
Response time	<100 μs
Excitation	380-nm to 420-nm (400-nm ideal)
Emission	600-nm to 720-nm
Photo-degradation rate	1% per minute (Excitation)
Shelf life	3-months
Filter	610-nm
ECCN	EAR99

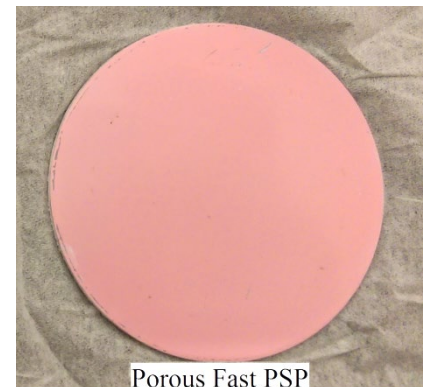

Available quantities: 100-, 200-, 400-, 750-ml

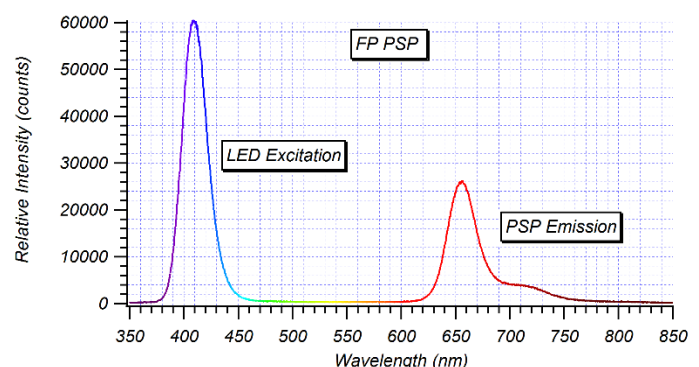
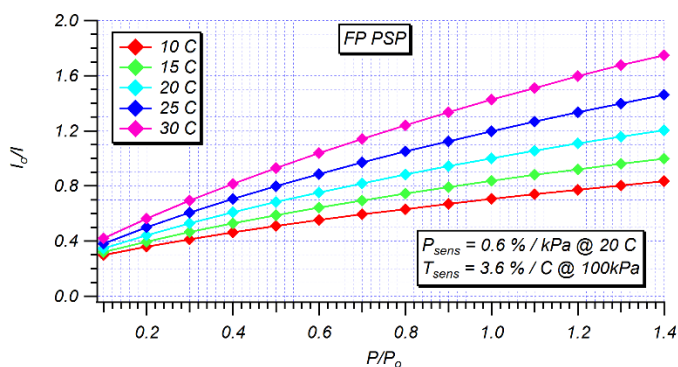

TEMPERATURE SENSITIVE PAINT

Traditional measurement techniques for acquiring surface temperature distributions on models have utilized embedded arrays of thermocouples and RTD's. This requires significant construction and setup time while producing data with limited spatial resolution. An alternative approach is to use temperature sensitive paint (TSP) to measure surface temperature. The advantages of temperature sensitive paint include non-intrusive measurements and high spatial resolution when compared to conventional measurement techniques. Image based temperature measurements using TSP are accomplished by coating the model surface with the paint and illuminating the surface with light of the appropriate wavelength. The luminescence from the surface is recorded using a CCD camera through a long-pass filter to separate the luminescent signal from the excitation light. The luminescence from the TSP is a function of the local temperature, and therefore, each pixel on the camera acts as a thermocouple.

A typical TSP consists of the luminescent molecule and an oxygen impermeable binder. The basis of the temperature sensitive paint method is the sensitivity of the luminescent molecules to their thermal environment. The luminescent molecule is placed in an excited state by absorption of a photon. The excited molecule deactivates through the emission of a photon. A rise in temperature of the luminescent molecule will increase the probability that the molecule will return to the ground state by a radiation-less process, this is known as thermal quenching. The temperature of the painted surface can be measured by detecting the fluorescence intensity of the luminescent paint.

TSPs are used to measure surface temperature distributions to estimate heat transfer rates over a surface and to capture boundary layer transition from laminar to turbulent flow.

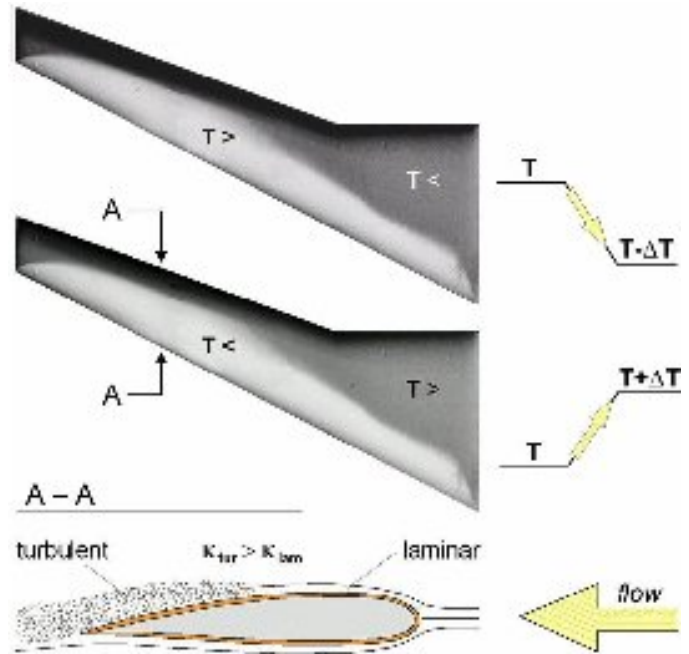

Boundary layer separation using TSP
Image courtesy of DLR

Inclined Jet Impingement

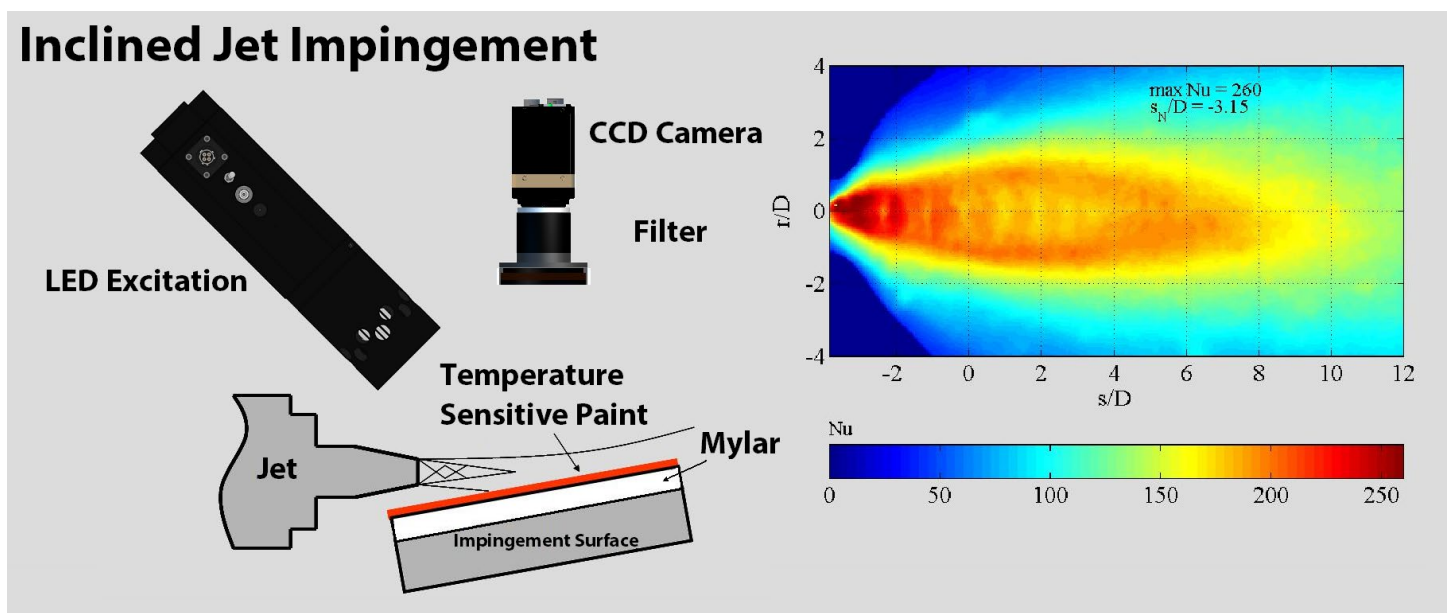

1.4 | Temperature Sensitive Paints

UNITEMP™ TEMPERATURE SENSITIVE PAINT

(Product ID: UNT-XXX)

UniTemp is a single-luminophore, single application temperature sensitive paint. The TSP may be applied to most surfaces, but a screen layer such as SCR or FB is recommended for plastics and rapid prototyping resins to protect the surface from solvent damage. A desirable feature of UniTemp is ease of application. Simply shake the can and spray the surface. The result is a single coat application paint that may be applied directly to most materials. UniTemp is an effective quantitative TSP. It is also effective in compensating for errors due to model displacement and deformation. UniTemp is recommended for both advanced TSP users who seek quantitative data and users who seek to gain experience with temperature sensitive paints.

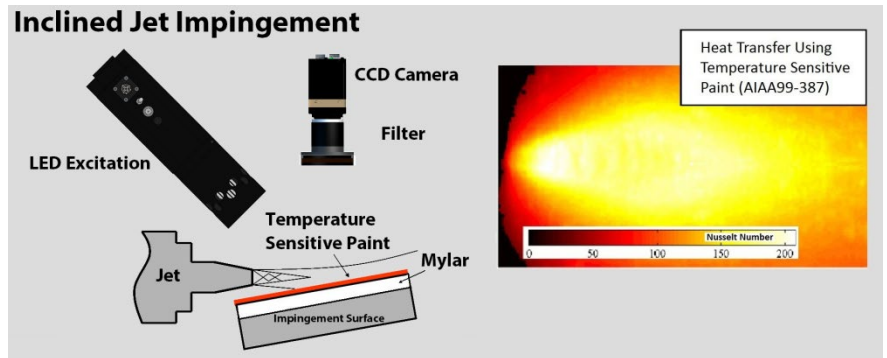

SPECIFICATIONS

Pressure sensitivity	0.0% per kPa
Pressure range	1-kPa to 10-MPa
Temperature sensitivity	0.9% per °C
Temperature range	10°C to 80°C
Response time	750 ms
Excitation	380-nm to 520-nm (460-nm ideal)
Emission	500-nm to 720-nm
Photo-degradation rate	1% per hour (Excitation)
Shelf life	12-months
Filter	550-nm
ECCN	EAR99



Available Quantities: 12-oz aerosol can (UNT-12), or 200-, 400, 750-ml

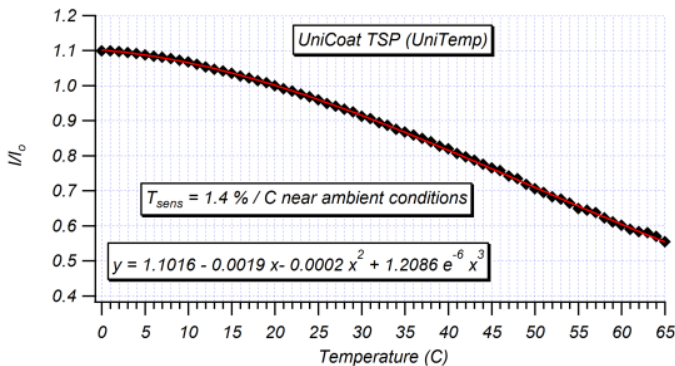

Calibration

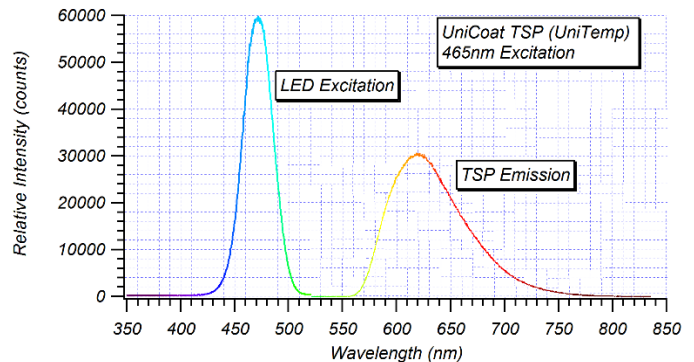

Spectral Response (TSP Emission Scaled)

CCTR™ TEMPERATURE SENSITIVE PAINT

(Product ID: CCTR-XXX)

CCTR is a temperature sensitive paint in a clear coat binder. It is easy to apply with a spray gun. Peak absorption wavelength for CCTR is near 470-nm and is typically excited with ISSI's LM2X-DM-460 standard LEDs. With a peak emission around 620-nm, the excitation light can easily be separated from the emission with an optical filter. CCTR offers slightly better temperature sensitivity than UniTemp TSP.

SPECIFICATIONS

Pressure sensitivity	0.0% per kPa
Temperature sensitivity	1.8% per °C
Temperature range	-10°C to 60°C
Response time	750-ms
Excitation	400-nm to 550-nm (peak 470-nm)
Emission	600-nm to 750-nm (peak 620-nm)
Photo-degradation rate	1% per hour
Shelf life	12-months
Filter	570-nm
ECCN	EAR99

Available Quantities: 200-, 400, 750-ml

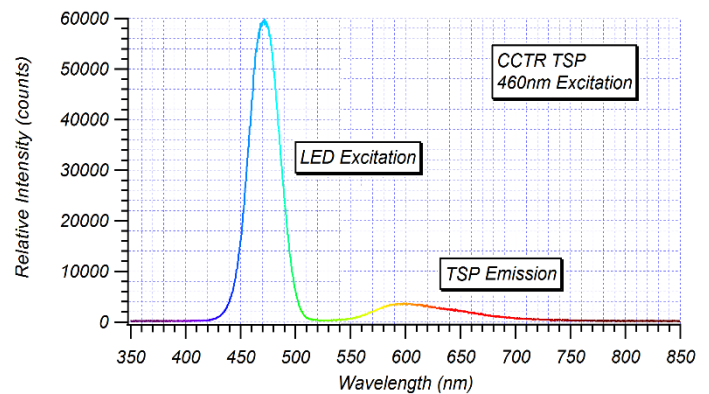
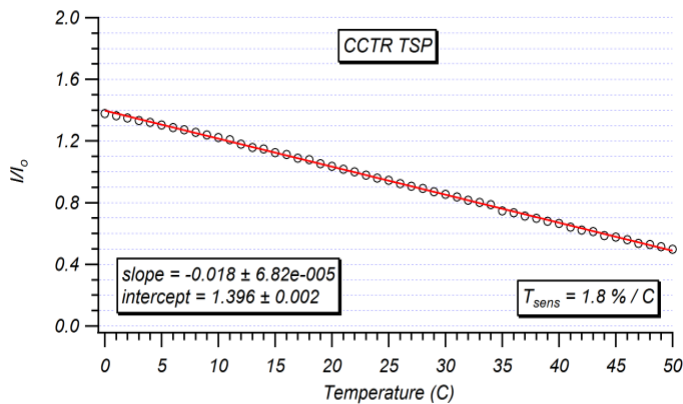
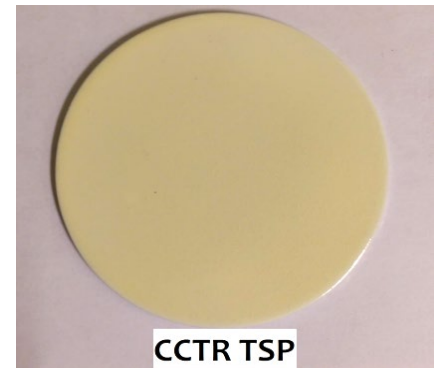

1.5 | Base Coatings

Base coatings are applied to models prior to PSP. Base coatings are used to cover up imperfections or roughness on the model surface, shield the model surface from the solvents in PSP, provide better PSP adhesion to the model and to provide a more reflective background for better illumination. Base coatings can be applied using the same painting gun as PSPs.



FIB BASECOAT

(Product ID: FB-XXX)

The FIB Basecoat is a single application screen layer that is sprayed onto a model surface with paint spraying equipment to mask machining marks and stains or to mask surfaces that fluoresce and interfere with PSP or TSP data. FIB basecoat also provides a uniformly reflective surface to minimize illumination errors and enhance the emission of PSP and TSP. This formulation is recommended for surfaces where the base coating and PSP or TSP absolutely must be removed from the surface using common mild solvents.

Available quantities: 200-, 400-, 750-ml



Wing Model Painted with FIB Basecoat (Left), Wing Model with FIB Basecoat, Over-Sprayed with BinaryFIB® (Right)

EPOXY SCREEN LAYER

(Product ID: SCR-XXX)

Epoxy Screen Layer (SCR-XXX) is a two-part formulation designed to be applied to surfaces using conventional paint spraying equipment to mask machining marks and stains or to mask surfaces that fluoresce and interfere with PSP or TSP data. Epoxy Screen Layer comes in two parts and is mixed 1:1. Epoxy Screen Layer provides the highest quality surface screen layer with superior solvent resistance and improved opacity. The solvent resistance means PSP can be applied over it and removed many times without the need to reapply the screen layer each time. Epoxy Screen Layer needs to be fully cured before the PSP is applied by curing at elevated temperatures (90C for ~4 hours) or by allowing a few weeks to air cure to prevent the screen layer from interacting with the PSP and compromising data. Epoxy Screen Layer is a permanent screen layer. It is recommended for all models but required for plastic models which are not solvent resistant.

Available quantities: 200-, 400-, 750-ml

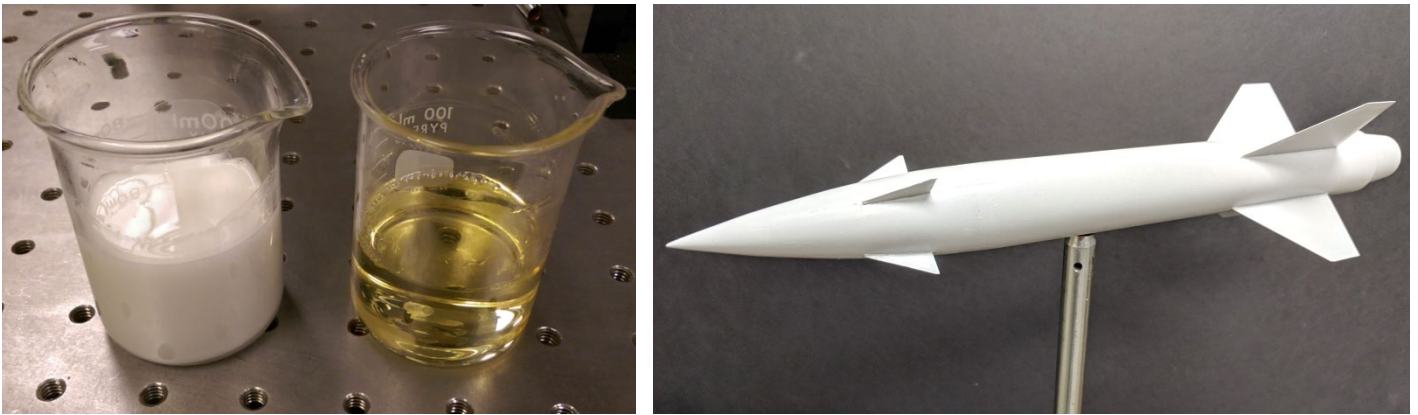

(Left) Epoxy Screen Layer Part A (White) and Part B (Yellow/clear), (Right) Missile Model Painted with Screen Layer

1.6 | PSP Starter kit

(Product ID: PSP-K)

A PSP/TSP starter kit is available for purchase. The PSP/TSP starter kit contains each of the 12-oz aerosol spray cans: UNC-12, BUNC-12, UNT-12, 400-ml of Binary FIB, UniFIB and FIB Basecoat as well as an overhead paint gun, air brush and small air brush compressor.



2 | LED Light Sources

LED ILLUMINATION LAMPS

Light emitting diode (LED) arrays are the most convenient and cost-effective means to excite fluorescent dyes in experimental measurement studies including pressure and temperature sensitive paints to and particle shadow velocimetry. Using the correct light source is critical to the accuracy of the measurement. Optical measurement techniques require a sufficiently energetic, low noise, stable illumination source if quality data is to be acquired. Any variation in output illumination from the excitation source will cause measurement errors. ISSI LED arrays contain proprietary optical and electrical filtering to achieve very stable, narrow-band illumination.

LEDs are available in 2-, 3- and 4-inch sizes and with air-, vortex- or water-cooling. Select models are available with one of two drivers. The DM driver is used to operate the LED in long-pulse or continuous mode and the DMHP driver is used for short-pulse, high power mode (used for lifetime accumulation acquisition). All models of LEDs are available in 400- and 460-nm wavelengths standard. Other wavelengths are available upon request.

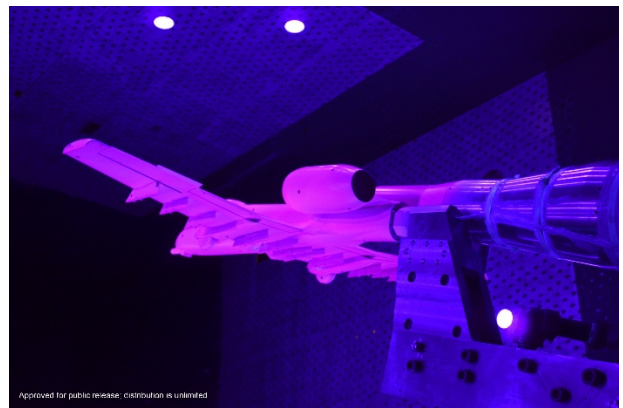

ISSI LEDs Mounted in AEDC 16T Wind Tunnel During Pressure Sensitive Paint Tests, Photo Credit US Air Force

Uses

Molecules within **pressure sensitive paint** are excited by a narrow band LED light source of a specific peak wavelength. Once excited, these molecules will either fluoresce, emitting a photon of a longer wavelength, are quenched by local oxygen molecules (pressure sensitive paint) or are thermally quenched (temperature sensitive paint). This quenching rate determines the fluorescent intensity of the paint layer. The fluorescent levels can be used to estimate pressure or temperature using a previously determined calibration of the paint.

Particle Shadow Velocimetry uses a pulsed LED light source to characterize seeded flow fields near surfaces in small regions of interest in water and air. The technique is a cost-effective alternative to some Particle Image Velocimetry (PIV) applications that uses shadows cast by particles to track movement rather than the traditional light scattering PIV technique using expensive lasers.

Schlieren photography is a technique utilized to image fluid density gradients. The density gradient of the fluid gives rise to refractive index changes which distort the collimated beam of light between two mirrors and thus the point of focus. Using a knife edge, variable density slide or color slides at the focus to exploit this effect allows high-contrast imaging of otherwise nearly invisible density gradients.

2.1 | Air-cooled LEDs

CONTINUOUS 2-INCH AIR-COOLED LED LIGHT SOURCE

Product ID: LM2X-DM-XXX

The continuous 2-inch, air-cooled LED light source provides uniform, stable illumination, for pressure and temperature sensitive paint measurements. The LED is designed for radiometric acquisition systems. It can operate continuously (DC) or in a long-pulsed mode. The operation mode is set using an external toggle switch. In long-pulsed mode, the pulse width and frequency are set by sending an external TTL signal to the BNC trigger input. The duty cycle may be set from 0% to 100%. The light distribution from the unit is approximately Gaussian for distance greater than 18-inches [45-cm] from the source. The units are available in standard wavelengths of 400-nm and 460-nm, however, other wavelengths are available upon request.

Ordering information: LM2X-DM-XXX (LED head with DC/long pulse driver -XXX denotes wavelength)

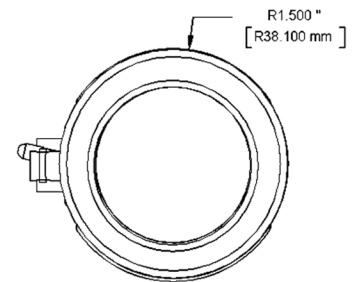
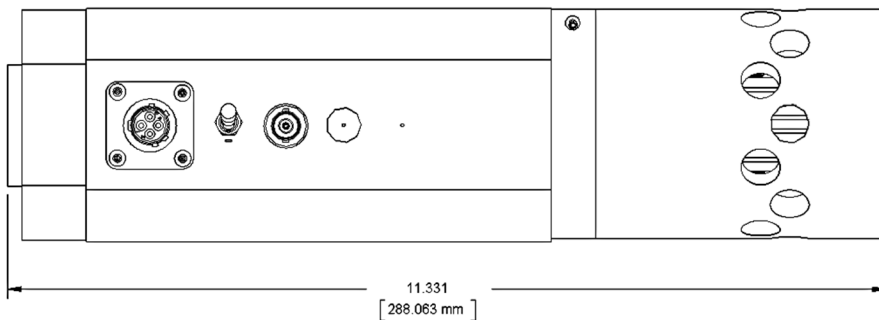

SPECIFICATIONS

Output power	~5 W (optical)
Input	48VDC, 2.5A
Stability	~0.1 % per hour after warm-up
Maximum duty cycle	100%
Rise time (10% - 90%)	< 5- μ s
Fall time (90% - 10%)	~ 250- μ s
Operating temperature range	-10°C to 60°C
Wavelength	400-nm and 460-nm (Standard)
FWHM	+/- 18-nm
Warranty	12-months
ECCN	EAR99

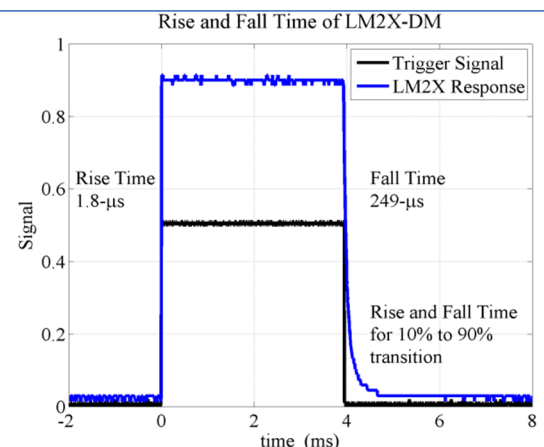

LIFETIME 2-INCH AIR-COOLED LED LIGHT SOURCE

Product ID: LM2X-DMHP-XXX

The lifetime 2-inch, air-cooled LED light source provides uniform, stable illumination, for pressure and temperature sensitive paint measurements. The LED is designed for lifetime acquisition systems. The system is overdriven, giving it a higher peak power per pulse than the continuous LED system. Pulse width and frequency are set by sending an external TTL signal to the BNC trigger input. Because it is overdriven, the duty-cycle is limited to 5%. The maximum pulse width is limited to 1-ms. A governor circuit in the system prevents the system from exceeding 5% duty cycle, which could damage the LED. The light distribution from the unit is approximately Gaussian for distances greater than 18-inches [45-cm] from the source. The units are available in 400-nm and 460-nm, however, other wavelenths are available upon request.



Ordering information: LM2X-DMHP-XXX (LED head with short-pulse/high-power driver –XXX denotes wavelength)

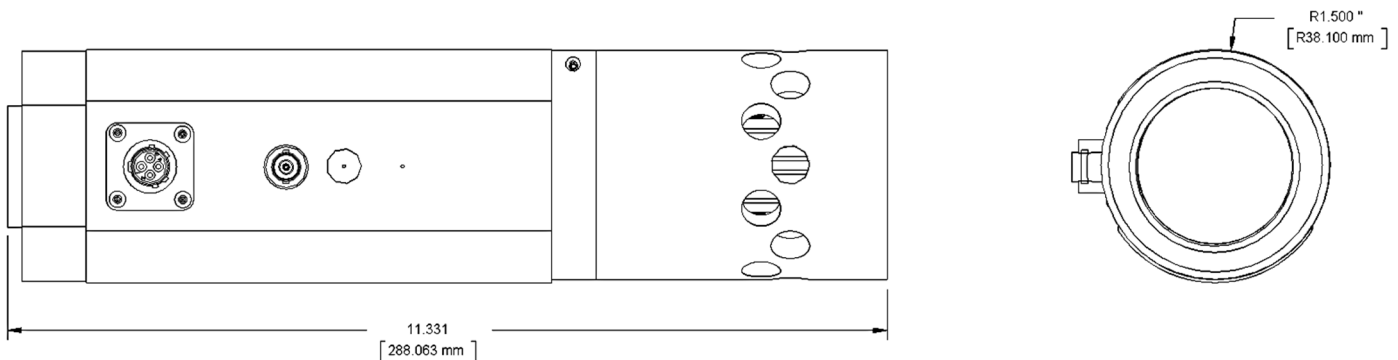

SPECIFICATIONS

Output power	>1.1 W (optical)
Input	48VDC, 2.5A
Stability	~0.1 % per hour after warm-up
Maximum duty cycle	5%
Rise time (10% - 90%)	< 200 ns
Fall time (90% - 10%)	~ 100 ns
Maximum Pulse Width	1 ms
Operating temperature range	-10°C to 60°C
Wavelength	400-nm and 460-nm (Standard)
FWHM	+/- 18-nm
Warranty	12-months
ECCN	EAR99

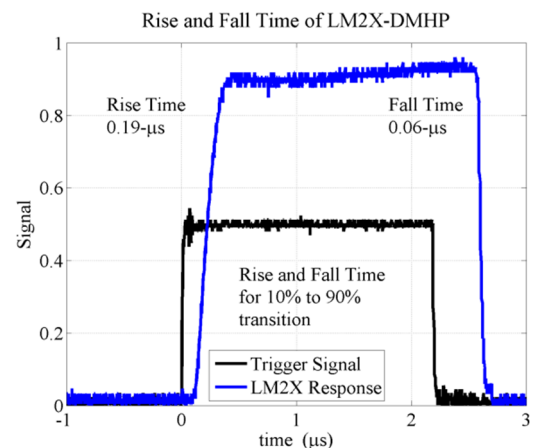

2-INCH AIR-COOLED LED ORDERING OPTIONS

Product ID: LM2X-MOD

For applications where space is limited, the 2-inch, air cooled LED module can be made with a separated head and driver section with power umbilical to connect the two pieces.



The modification includes end caps for the head and driver with 15 pin mil spec d-sub connector and 1 meter cable for power and trigger input.



4-INCH AIR-COOLED LED LIGHT SOURCE

Product ID: LM4X-DM-XXX

The continuous 4-inch, air-cooled LEDs offer uniform, stable illumination with excellent output power. The unit operates continuously or in long-pulse mode, designed for radiometric systems using the continuous/long-pulse driver (module for radiometric). The operation mode is set using an external toggle switch. In long-pulsed mode, the pulse width and frequency are set by sending an external TTL signal to the BNC trigger input. The duty cycle may be set from 0% to 100%. The 4-inch LED offers a 4-5X increase in power over the continuous 2-inch, air-cooled LED, 5X faster rise and fall times for pulsed operation, and increased temperature range of operation. The light distribution from the unit is approximately Gaussian for distances greater than 18-inches [45-cm] from the source. The units are available in 400-nm and 460-nm, however, other wavelengths are available upon request.



Ordering information: LM4X-DM-XXX (LED head with DC/long pulse driver -XXX denotes wavelength)

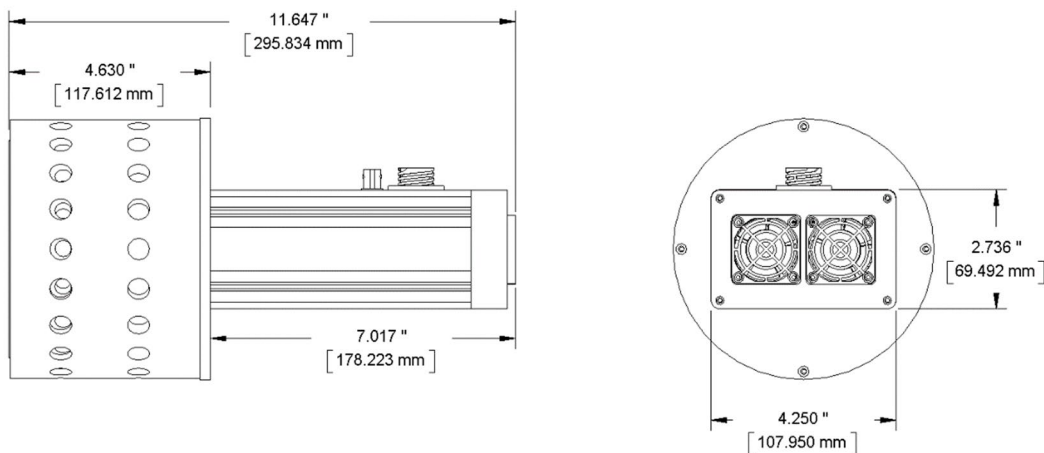

SPECIFICATIONS

Output power	25.0 W (optical)
Input	31VDC, 8A @ 120VAC
Stability	~0.2 % per hour after warm-up
Maximum duty cycle	100%
Rise time (10% - 90%)	< 100 μ s
Fall time (90% - 10%)	< 100 μ s
Operating temperature range	-10°C to 60°C
Wavelength	400-nm and 460-nm (Standard)
FWHM	+/- 18-nm
Warranty	12-months
ECCN	EAR99

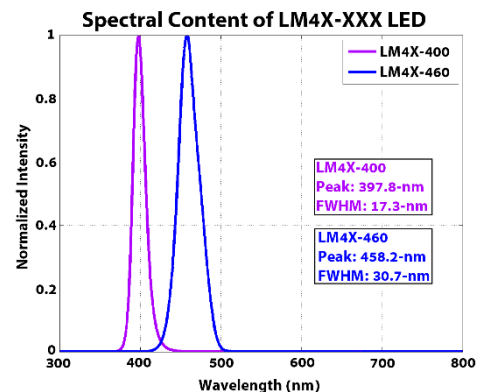

2.2 | Water-cooled LEDs

Water-cooled LEDs provide a significant increase in output power needed in large test facilities. Water-cooled LEDs are necessary in large wind tunnels and in applications where higher light intensity is needed, like fast PSP. Large test sections require more excitation light because the model is further from the data acquisition system. Water cooling allows the LEDs to be driven harder than the air-cooled systems. Water-cooled LEDs provide ~3 times the output power of their comparable 2-inch air-cooled varieties. Three parts compose the water-cooled LED: the control box, the LED head and the umbilical cable. The control box houses the drive electronics, power supply and water-circulation system. The umbilical supplies the cooling water and the electrical connection between the control box and the LED head. Umbilical cables are available in 10-, 20- and 30-foot lengths. External water is supplied to the control module.

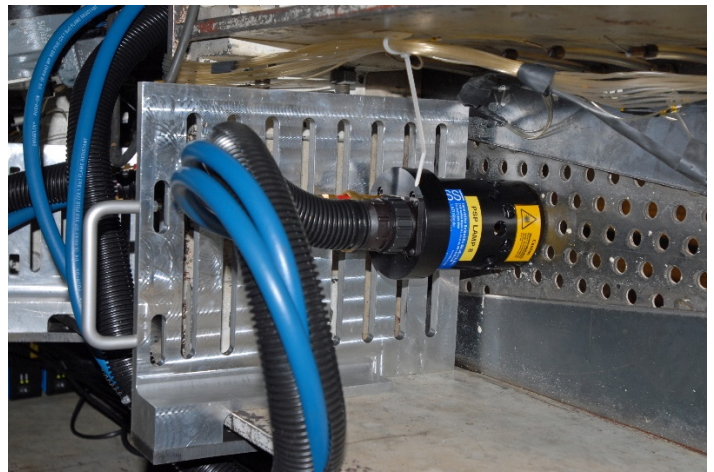
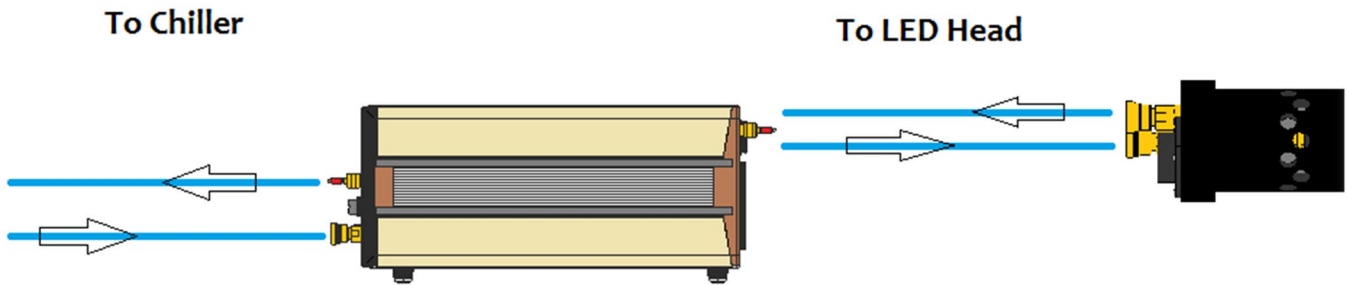

ISSI LEDs Mounted in Cavity Acoustics Fast PSP Test (Left), Courtesy US Air Force Research Laboratory, ISSI Water-Cooled LEDs mounted in the ARA Transonic Wind Tunnel (Right), Courtesy of ARA, Bedford, UK

CONTINUOUS 2-INCH WATER-COOLED LED LIGHT SOURCE

Product ID: LM2XX- XXX, DC2XX

The continuous 2-inch, water-cooled LED light source provides uniform, stable illumination, for pressure and temperature sensitive paint measurements. The unit operates continuously or in long-pulse mode, designed for radiometric systems by connecting to the DC2XX driver box (module for radiometric). The operation mode is set sending an external TTL trigger pulse to the DC2XX to set the output pulse width and frequency. The duty cycle may be set from 0% to 100%. The light distribution from the unit is approximately Gaussian for distance greater than 18-inches [45-cm] from the source. The units are available in 400-nm and 460-nm, however, other wavelengths are available upon request. This unit surpasses the performance of the 2-inch, air-cooled system as it offers a significant increase in power (3-4 times that of the 2-inch, air-cooled system). Maximum input pressure to the control box is 90 psi. An external water source is required to cool the LED module. The control box contains a flow meter and safety circuit to shut off power to the LED if the flow rate is too low or the LED approaches overheat temperatures.



Ordering information: LM2XX-XXX (LED head with umbilical. -XXX denotes wavelength). DC2XX (DC/long-pulse control box and driver with power supply).

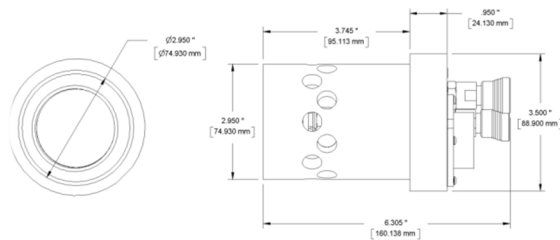

LM2XX-XXX LED Head

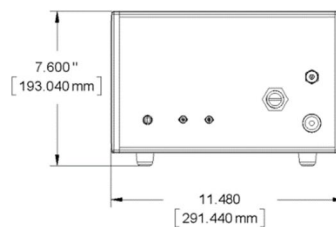

DC2XX Control Box

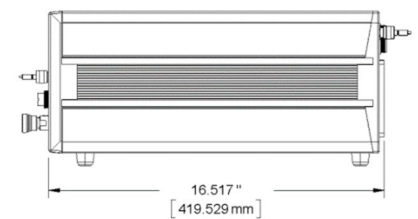

SPECIFICATIONS

Output power	12-14 W (optical)
Input	24VDC, 8.2A
Stability	~0.1 % per hour after warm-up
Maximum duty cycle	100%
Rise time (10% - 90%)	< 600 ns
Fall time (90% - 10%)	< 300 ns
Operating temperature range	-10°C to 60°C
Wavelength	400-nm and 460-nm (Standard)
FWHM	+/- 18-nm
Warranty	12-months
ECCN	EAR99

LIFETIME 2-INCH WATER-COOLED LED LIGHT SOURCE

Product ID: LM2XX- XXX, PUL2XX

The lifetime 2-inch, water-cooled LED light source provides uniform, stable illumination for pressure and temperature sensitive paint measurements. The system is overdriven and designed for lifetime acquisition systems by connecting to the PUL2XX driver box (module for lifetime). Because it is overdriven, the duty-cycle is limited to 5%. Operation is controlled by applying a TTL voltage to the external BNC on the PUL2XX module. The maximum pulse width is limited to 1- μ s. A governor circuit in the PUL2XX prevents the system from exceeding 5% duty cycle, which could damage the LED. The light distribution from the unit is approximately Gaussian for distance greater than 18-inches [45-cm] from the source. The units are available in 400-nm and 460-nm packages, however, other wavelengths are available upon request. This unit surpasses the performance of the 2-inch, air-cooled overdriven system as it offers a significant increase in power (~2 times that of a 2-inch, air-cooled overdriven system). Maximum input pressure to the control box is 90 psi. An external water source is required to cool the LED module. The control box contains a flow meter and safety circuit to shut off power to the LED if the flow rate is too low or the LED approaches overheat temperatures.



Ordering information: LM2XX-XXX (LED head with umbilical. -XXX denotes wavelength). PUL2XX (Overdriven control box and driver with power supply).

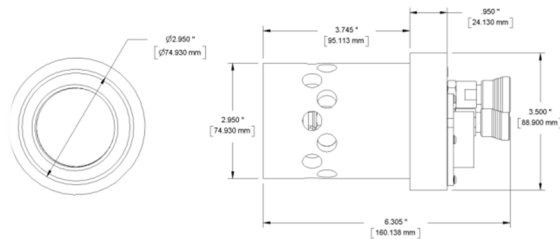

LM2XX-XXX LED Head

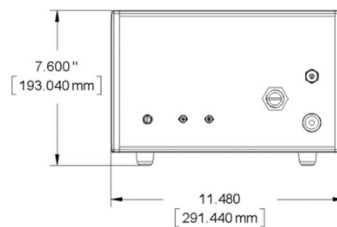

PUL2XX Control Box

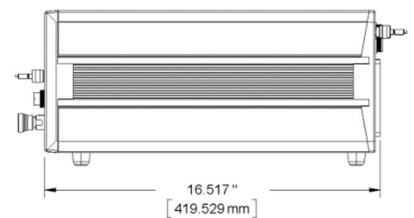

SPECIFICATIONS

Output power	~1.6-2.4 W @ 5% Duty Factor
Input	48VDC, 12.5A
Stability	~0.1 % per hour after warm-up
Maximum duty cycle	5%
Rise time (10% - 90%)	< 300 ns
Fall time (90% - 10%)	< 125 ns
Operating temperature range	-10°C to 60°C
Wavelength	400-nm and 460-nm (Standard)
FWHM	+/- 18-nm
Warranty	12-months
ECCN	EAR99

2.3 | Vortex-Cooled LEDs

Where water-cooling is not an option but maximum power is needed, ISSI's Vortex-Cooled LEDs are the answer. Vortex-cooled LEDs maximize performance without the use of water for simpler system integration into your test facility. The LEDs use a Ranque-Hilsch vortex tube device to provide cool air to the LEDs. Clean and dry compressed air must be available to operate the vortex cooling system.

The vortex-cooled LED system (including 2 heads) offers more power than any other ISSI LEDs currently available. Stronger, next-generation LEDs are used in the vortex-cooled system to provide increased performance. Each LED head can output 18W in optical power at 400-nm.

Each control box can also do more than their predecessors. The vortex cooling system in each control is capable of cooling two LEDs, minimizing components and maximizing performance. With a complete system, 40W in total output power can be achieved. The control boxes are conveniently rack-mountable for standard 3U rack size. Two control boxes can be mounted side-by-side in a standard 19-inch rack.

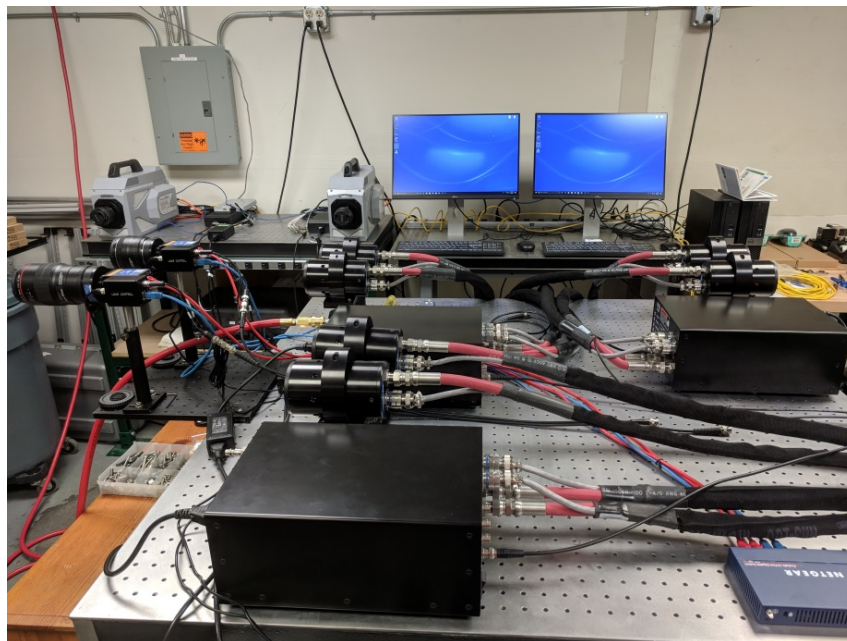
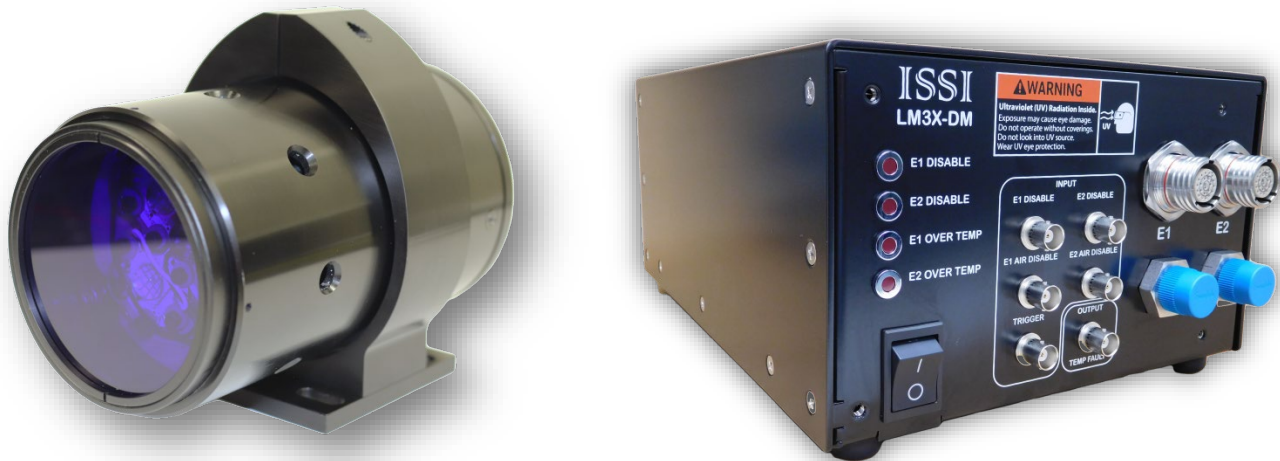

Vortex-Cooled LEDs Set Up for a Fast PSP Test

CONTINUOUS 3-INCH VORTEX-COOLED LED LIGHT SOURCE

Product ID: LM3X-XXX, DC3X, UM3X-XX

The LM3X is a high-power, air-cooled, rack-mountable, 3-inch LED light source that provides uniform, stable illumination for pressure and Temperature Sensitive paint measurements. The unit offers a significant increase in power over the previous generation products (3-4 times that of a single LM2XX head). Its small form factor and large optical power density make it a class leading solution for large scale testing and installations. The LM3X has been designed to operate safely in a pulsed or continuous DC operation. It requires no external chiller, only standard shop air for operation.

The DC3X control box can operate and cool two LM3X LED modules via umbilical which deliver power and cooled air. The control box is rack mountable with the included rack ears.

Ordering information: LM3X-XXX (LED head, -XXX denotes wavelength). DC3X (Overdriven control box and driver with power supply). UM3X-XX umbilical control and cooling cable. -XX denotes length. 10-, 20- and 30-ft available.

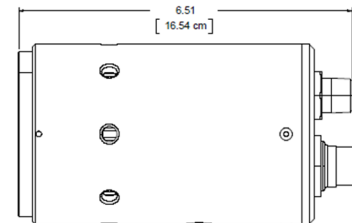
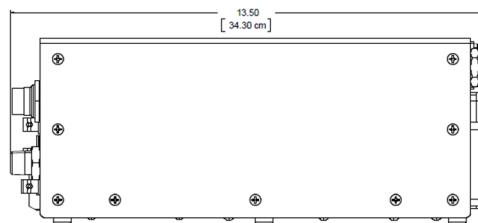
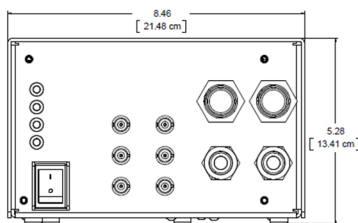

SPECIFICATIONS

Input Power	100-240 VAC, 50-60Hz, 8.2A
Optical Output Power	18 W per Emitter (36 W Total with 2 heads)
Wavelengths	400-, 460-nm (standard)
Operating Temperature	2-50 °C
Required Supply Air	60 scfm (1,700 lpm) @ 90 psi (Dry)
Air Inlet	¼" NPTF
Noise Level	82 dB
Length x Width x Height (Drive Assembly)	8.4" x 12.5" x 5.5" (213 mm x 317 mm x 139 mm)
Weight (Drive Assembly)	12.5 lbs.
Rack Height	3U
Length (LED Emitter)	6.5"
Diameter (LED Emitter)	3.5"
Weight (LED Emitter)	2.5 lbs.
Umbilical Length	10 ft. (standard) (20- and 30-ft available)

2.4 | Special Applications

ISSI provides custom made LEDs upon request and also several models for different experimental applications. We work with customers to provide solutions to their applications. Customization includes specific output wavelengths or modified mechanical design to fit specialized test cells.

PARTICLE SHADOW VELOCIMETRY

Particle shadow velocimetry (PSV) utilizes low-power pulsed light sources such as LEDs to measure the displacement of seed particles in a flow. PSV images can also be used to characterize particle parameters such as size and shape. Since this is a volumetric illumination technique, it relies on the receiver optics to optimize the depth of field for the measurement. Any pulsed light system can be used as the light source; however, LEDs are particularly well suited since they can be overdriven in a short-pulse mode to produce intense sub-microsecond light pulses. Furthermore, the use of LEDs combined with a high speed camera results in a high-speed system with bandwidth of 10's of kHz. Because the technique does not rely upon weak-particle light scattering, lasers are neither necessary nor recommended for use with this approach.

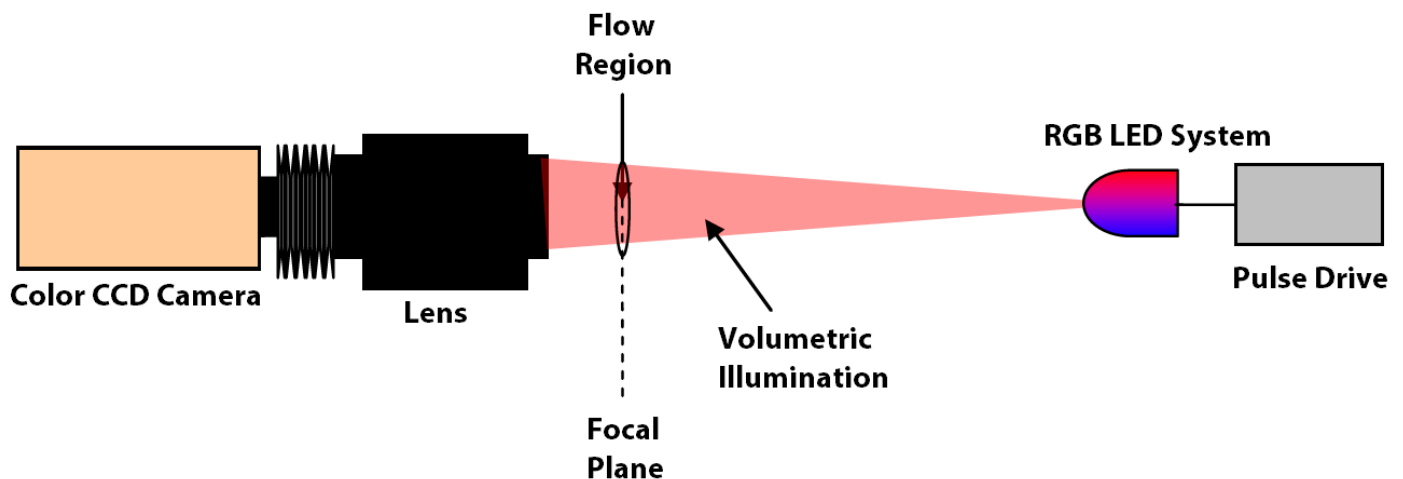

PSV uses light extinction (particle shadows) rather than light scattering in a laser sheet, resulting in high-quality particle imaging at much lower illumination levels. These safe illumination levels can be generated by a pulsed-LED system at a fraction of the cost of a pulsed laser. Multi-color LED illumination permits the use of a low-speed camera, further reducing system cost. Different color LEDs are sequentially pulsed, at high speed, and the sequential particle images are captured in a single frame on the camera's three color planes. Narrow depth-of-field optics are employed to image a two-dimensional plane within the flow volume, similar to what is achieved with a laser sheet. Measurement close to surfaces is possible because the system is not degraded by surface reflections which severely limit laser-based systems. The PSV approach is fully compatible with the seeding approaches and specifications used with conventional PIV systems.

PSV is not an alternative to Particle Image Velocimetry (PIV), but a complementary technique. PSV is advantageous over PIV close to structures or surfaces where laser scatter may cause issues with data collection.

Advantages of PSV compared to PIV

- Capable of increased measurement frequency since LEDs can be pulsed at higher rep rates than typical laser systems
- Due to the orientation and lower power of the LED, wall reflections are eliminated or significantly reduced compared to PIV
- Since PSV directly images the particle, information such as particle size and shape can be determined
- Optical alignment is typically simpler

Disadvantages of PSV compared to PIV

- LED pulse time is typically an order of magnitude longer than laser pulse time. This prevents the use of PSV in high speed applications.
- The depth of measurement in PSV is controlled by the camera optics, and is typically slightly thicker than the PIV light sheet.
- Higher magnifications or larger particles are required for PSV since the particle shadows are directly imaged instead of scattered light.

Cylinder in Cross Flow

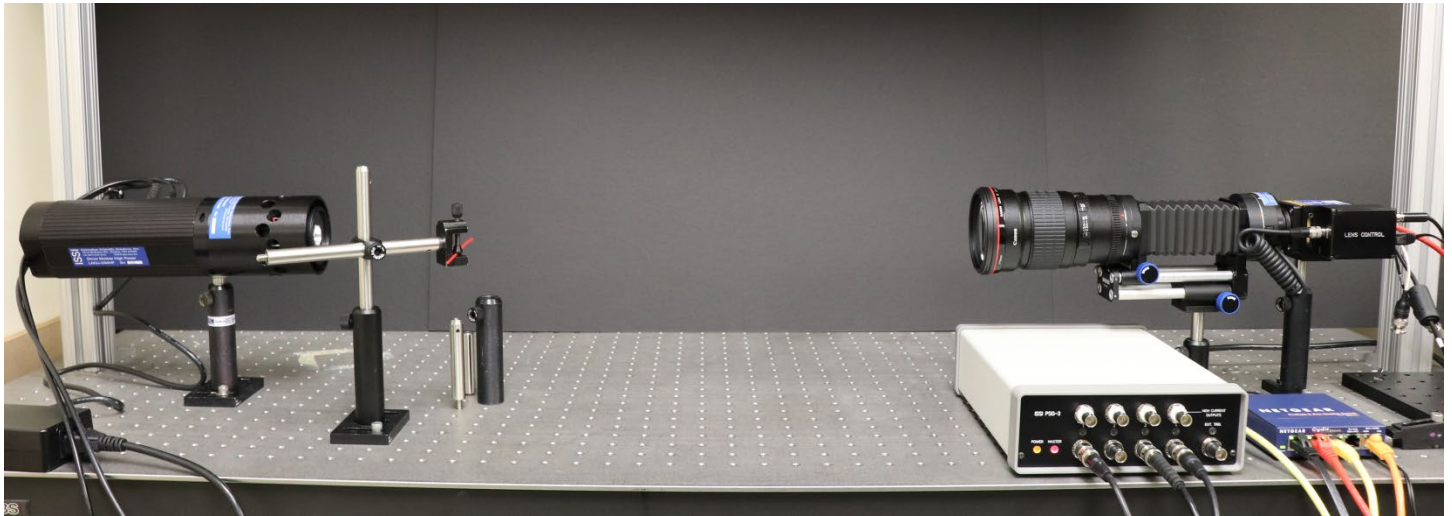
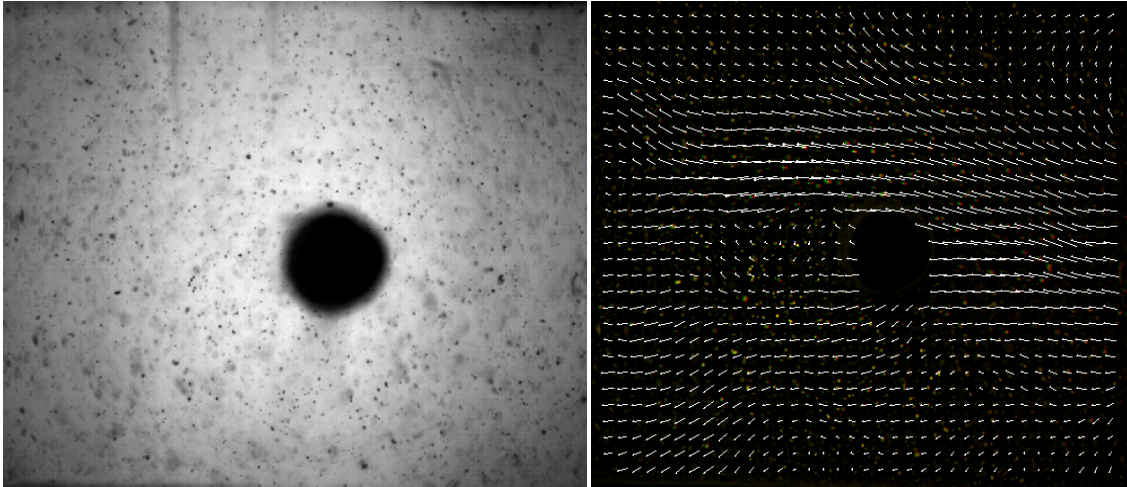

PIV Acquisition: EF Lens with AF Bellows and LC-2 Lens Controller and PSP-CCD-C Camera

3-COLOR PARTICLE SHADOW VELOCIMETRY LED

Product ID: LM2X-DMHP-RGB

The LM2X-DMHP-RGB is a 2-inch, air-cooled LED light source that provides three-color (Red, Green, and Blue) outputs from its LED head. This LED is used for Particle Shadow Velocimetry (PSV) to illuminate small seed particles in a flow field to measure velocity and particle density. The LM2X-DMHP-RGB has three BNC inputs to control the timing and pulse width of each of the output colors from an external pulse generator. The pulsed LED operation is controlled by applying a TTL voltage to the external BNC(s) on the module. The rise time is less than 200-ns and the fall time is less than 100-ns and the duty cycle is 5%. The light distribution from the unit is approximately Gaussian for distance greater than 18 inches from the source.



Ordering information: LM2X-DMHP-RGB (LED head with short-pulse/high-power driver)

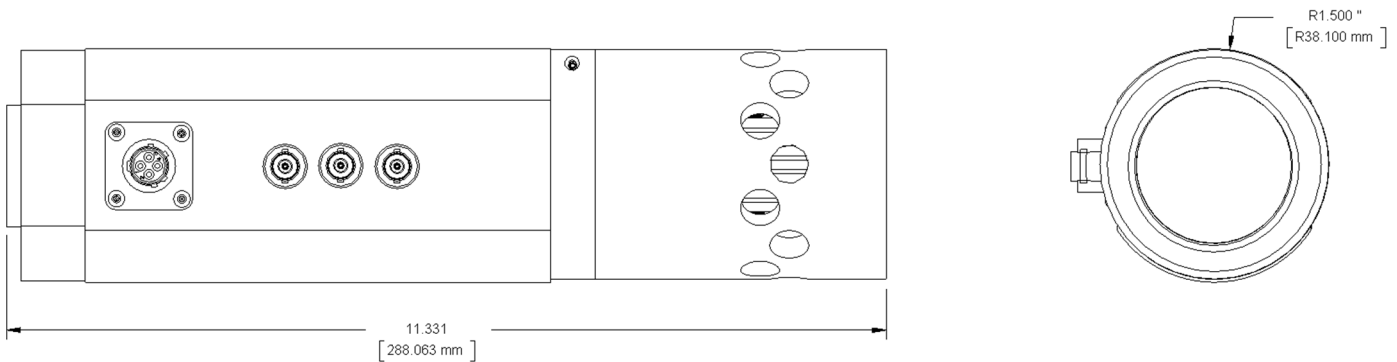

SPECIFICATIONS

Output power	2.0 W
Input	48VDC, 2.5A @ 120VAC
Stability	~0.1 % per hour after warm-up
Maximum duty cycle	5%
Rise time (10% - 90%)	< 200-ns
Fall time (90% - 10%)	< 100-ns
Operating temperature range	-10°C to 60°C
Wavelength	460-nm, 520-nm, 630-nm
FWHM	+/- 18-nm
Warranty	12-months
ECCN	EAR99

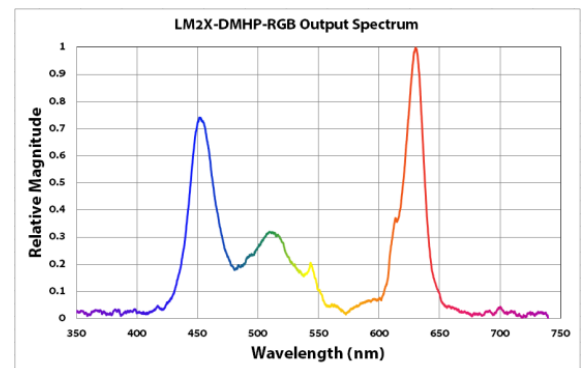

SCHLIEREN PHOTOGRAPHY

Schlieren photography is a technique utilized to image fluid density gradients. The density gradient of the fluid gives rise to refractive index changes which distort the collimated beam of light between two mirrors and thus the point of focus. Using a knife edge, variable density slide or color slides at the focus, the light intensity is cut in half by the knife edge. Refractive index changes in one direction are brighter and in the other direction are darker. This type of imaging is widely used in wind tunnel, heating, ventilation and air conditioning (HVAC) research.

Schlieren Experimental Setup

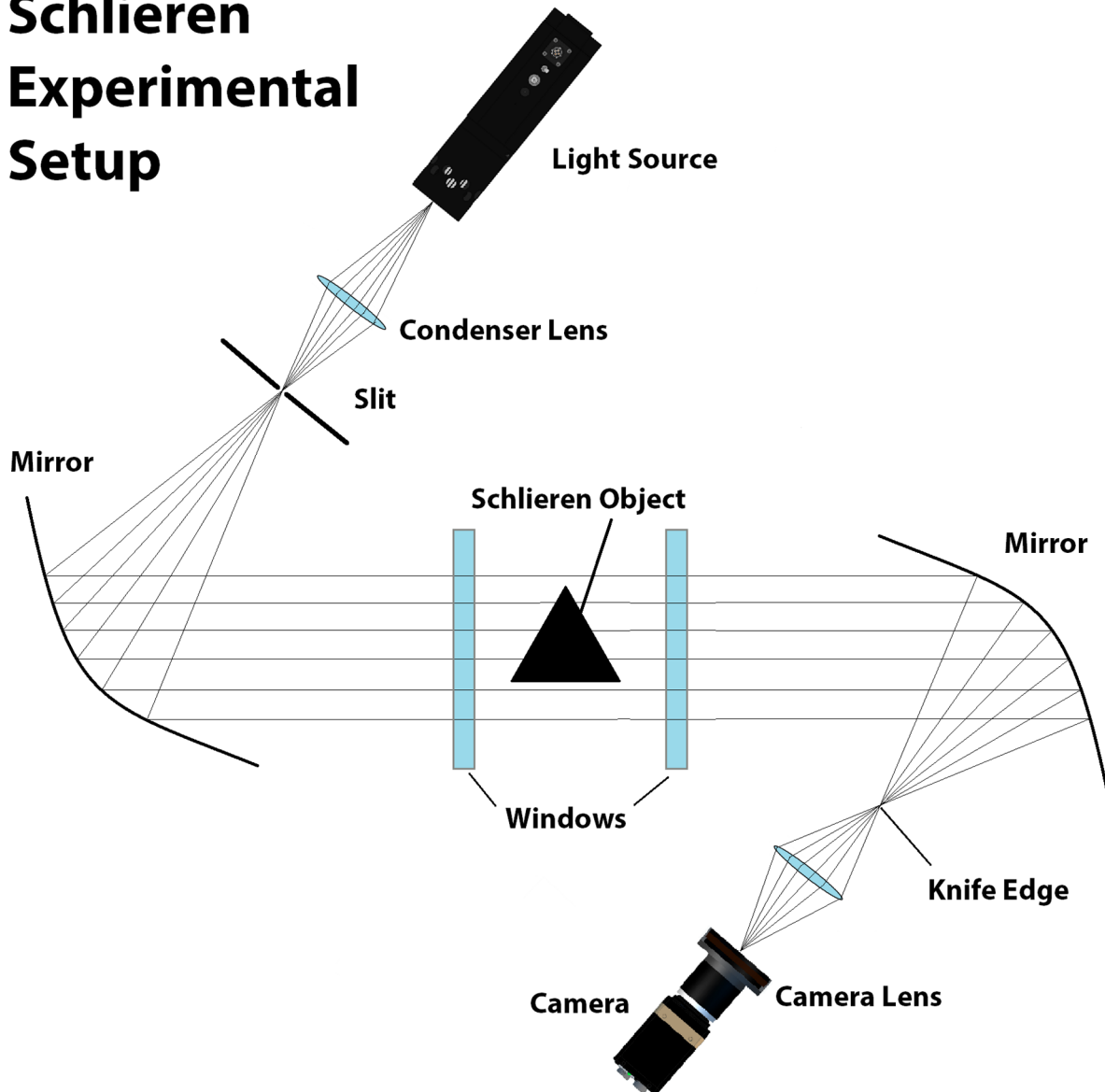

The ISSI product line includes a high-intensity LED point source with a variable slit attachment for use in schlieren photography. This LED is available in continuous/long-pulse and short-pulse/high-power mode. Output wavelength can be set to user specifications.

SCHLIEREN LED

Product ID: LMS-XXX

The LMS-XXX LED is a 2-inch, air-cooled LED light source used for schlieren and shadowgraph applications. The LMS-XXX has one BNC input to control the timing and pulse width of the output from an external pulse generator. The pulsed LED operation is controlled by applying a TTL voltage to the external BNC(s) on the module. The rise time is less than 200-ns and the fall time is less than 100-ns and the duty cycle is 5%. The light distribution from the unit is approximately Gaussian for distance greater than 18 inches from the source.

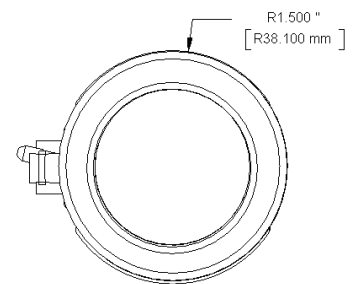
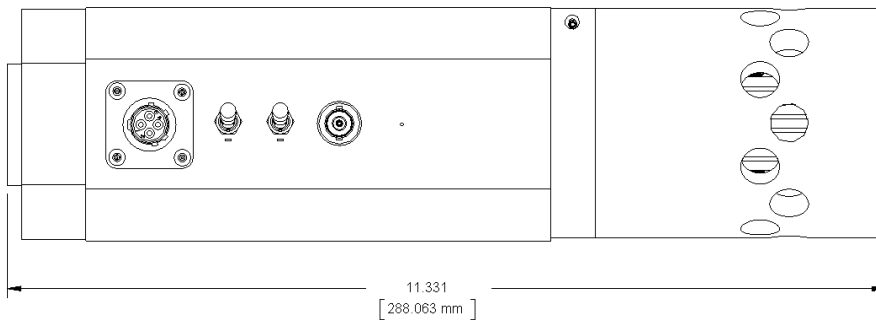

SPECIFICATIONS

Output power	~2-3 W
Input	48VDC, 2.5A @ 120VAC
Stability	~0.1 % per hour after warm-up
Maximum duty cycle	5%
Rise time (10% - 90%)	< 200-ns
Fall time (90% - 10%)	< 100-ns
Operating temperature range	-10°C to 60°C
Wavelength	User Specified
FWHM	+/- 18-nm
Warranty	12-months
ECCN	EAR99

2.5 | LED Accessories

PARABOLIC REFLECTOR & DIFFUSER

Product ID: LM2X-10R40-D

The LED reflector and diffuser is a 10-degree reflector for concentration of output light from an LM2 LED. The intensity output on the illuminated surface is 2-3 times greater in the focused area when using the reflector. The diffuser creates a more uniform Gaussian light distribution and reduces the structure pattern of the individual LEDs. The overall length is 4.75-inches (120.65 mm) and diameter of the diffuser section is 5-inches (127 mm).

The reflector screws onto the front of any 2-inch ISSI LED (LM2 Series). Remove the retaining ring on the front of the LED but be sure to leave the filter glass on the LED.

ECCN is EAR99.

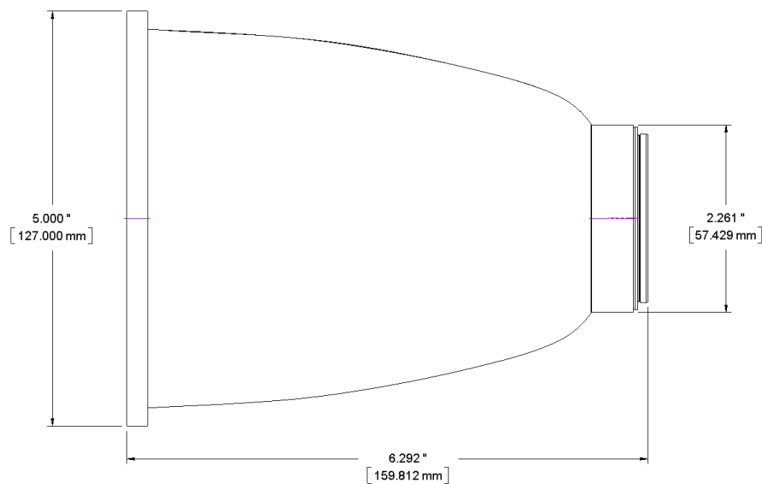
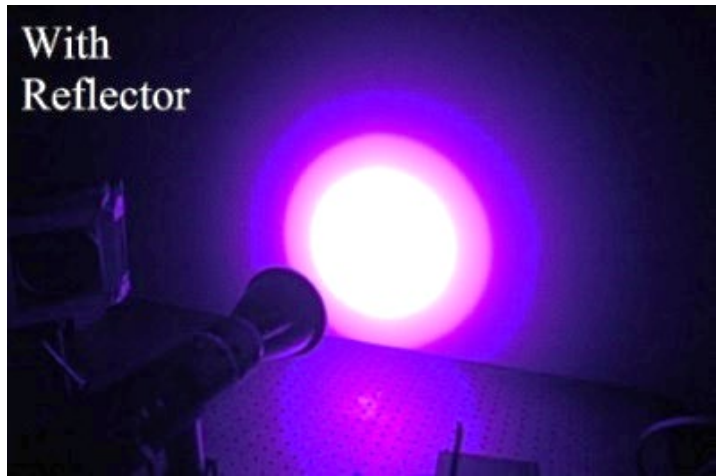
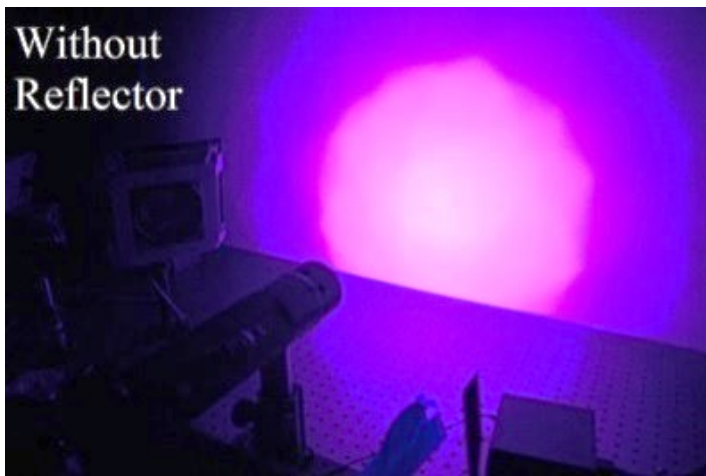

LED CLAMPING MOUNTS FOR LM2 SERIES LEDS

Product ID: LM2X-CL

The 2-inch LED mounting clamp is designed to mount all LM2 series LEDs on standard optical equipment and articulating mounts. This clamp securely holds the LED housing and allows greater mounting flexibility for LEDs in PSP and TSP systems.

The clamp is made from aluminum and has a black anodized finish. A bolt securely fixes the clamp around the LED housing while a series of rubber rings grip the LED housing.



LM2X-CL Shown with 2-Inch Air- and Water-Cooled LEDs

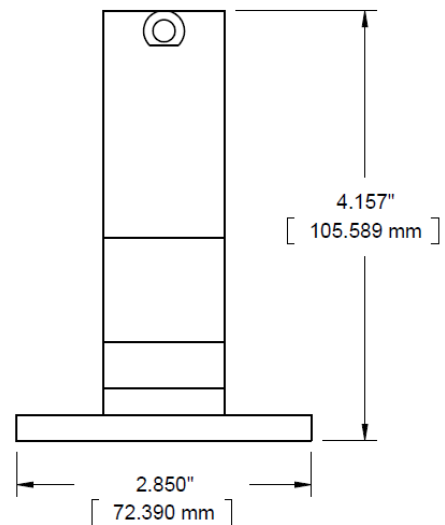
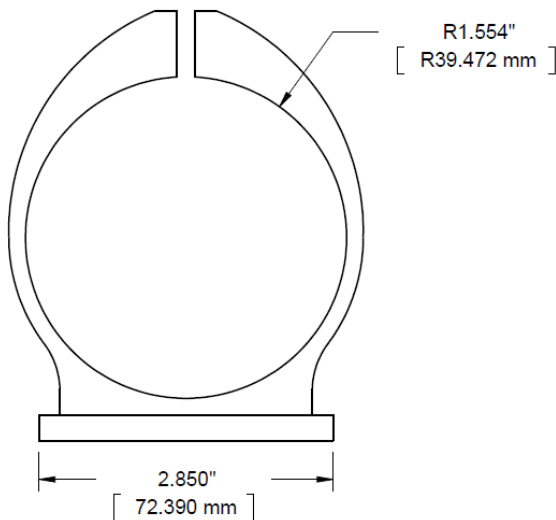

LED CLAMPING MOUNTS FOR LM3 SERIES LEDS

Product ID: LM3X-CL

The 3-inch LED mounting clamp is designed to mount all LM3 series LEDs on standard optical equipment and articulating mounts. This clamp securely holds the LED housing and allows greater mounting flexibility for LEDs in PSP and TSP systems.

The clamp is made from aluminum and has a black anodized finish. A bolt securely fixes the clamp around the LED housing while a series of rubber rings grip the LED housing.

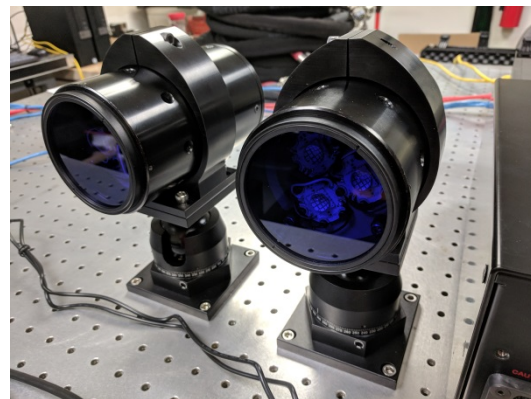

LM3X-CL Shown with 3-Inch Vortex-Cooled LEDs

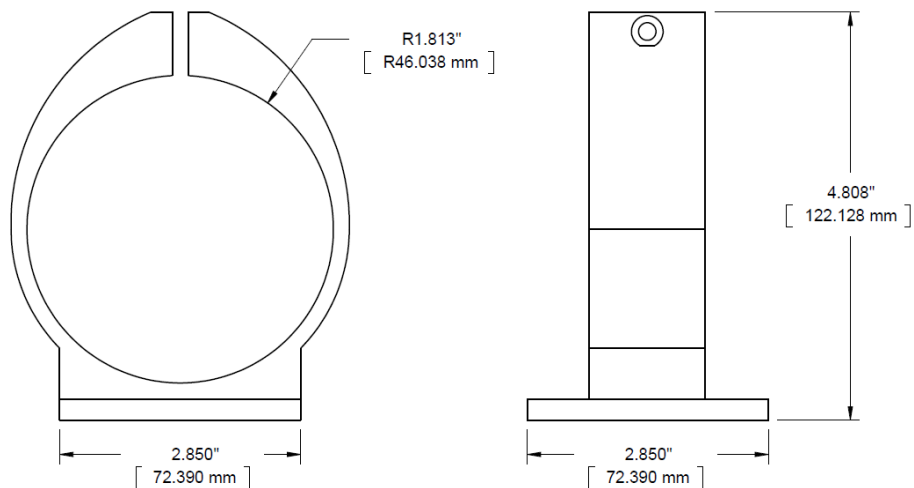

3 | Cameras

PSP & TSP CAMERAS

Charged coupled device (CCD) cameras are used to acquire images of paint response to pressure or temperature changes. Using the right sensitive scientific camera is paramount to making an accurate measurement with PSP and TSP.

CCD cameras suited for PSP and TSP measurements are characterized by:

1. Low Noise
2. High Signal-to-Noise Ratio (SNR)
3. High Linearity
4. High Dynamic Range
5. High Quantum Efficiency

These characteristics are required to produce high-quality and accurate PSP and TSP data from experiments. Ignoring these factors in a camera will lead to poor results from any PSP or TSP test.

CCD cameras used for PSP are referred to as “interline transfer” CCD cameras. Interline transfer CCD cameras mask every other row of the CCD sensor. After exposure the CCD shifts the charge from the active pixels to the masked pixels and the information is read out to memory or transferred from the camera to an external hard drive on a computer. This transfer to masked pixels is very fast ($\sim 1 \mu\text{s}$) and eliminates the need for a shutter.

The camera acquires fluorescence from PSP or TSP paints through a long-pass filter and stores or transfers the information for conversion to pressure or temperature using a previously determined calibration of the paint used.

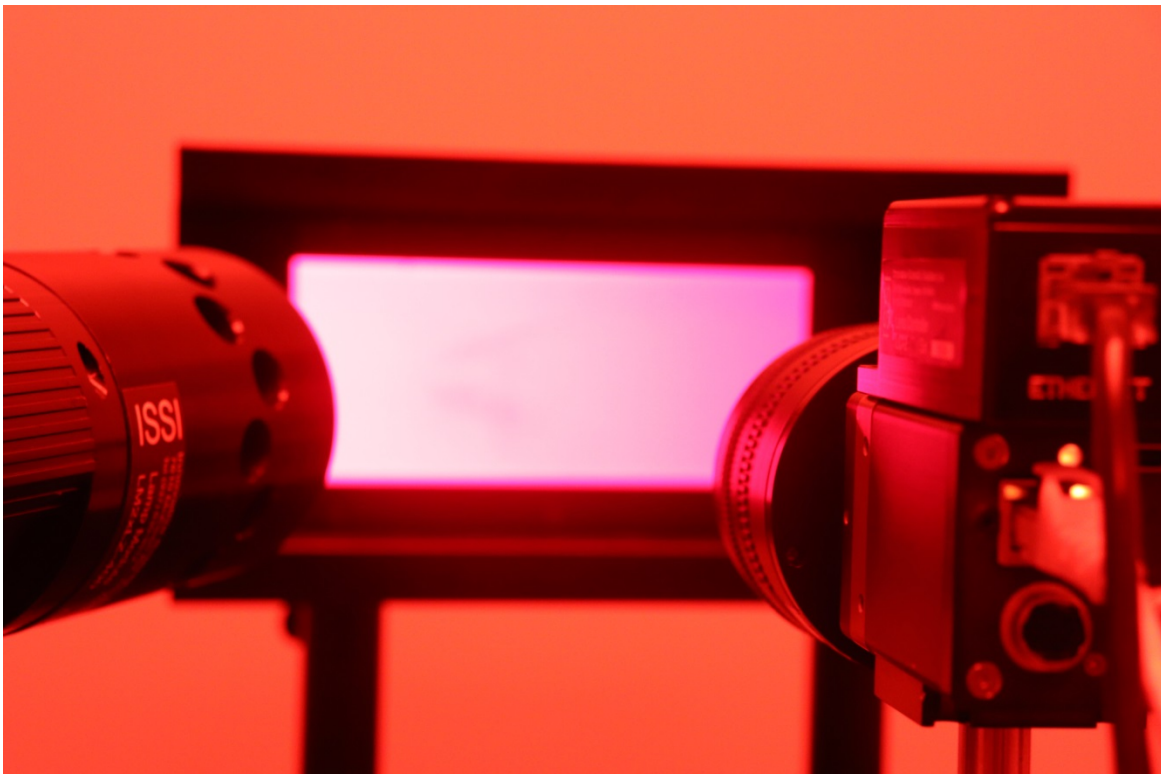

3.1 CCD CAMERAS

Monochrome CCD Camera

Product ID: PSP-CCD-M

The PSP-CCD-M is a 2-megapixel, c-mount, monochrome CCD camera designed to operate with single luminophore PSPs and TSPs. The camera is small and lightweight, allowing for an array of cameras to be mounted in small places for larger scale models and applications. The monochrome camera takes advantage of the full resolution of the array as all pixels act as pressure sensors.

The camera communicates over a Gigabit Ethernet connection with the acquisition computer. The camera has no on-board memory so data is streamed directly to the hard drive. The normal frame rate is 35 fps but can operate at 44 fps in overclock mode. The camera features a software trigger and external TTL trigger over BNC.

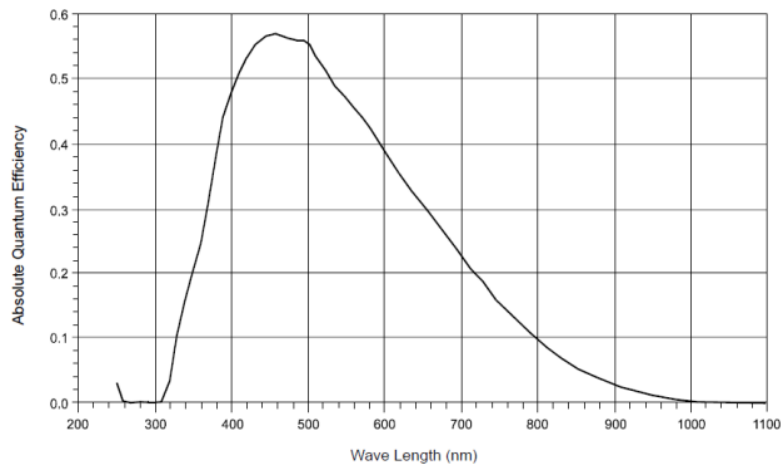

SPECIFICATIONS

Sensor	
Resolution	1600 x 1200 (active)
Type	KAI-2020 CCD
Format	11.89 mm (H) x 8.94 mm (V), 14.8 mm diagonal (1" optical format)
Pixel Size	7.4 μm
Frame Rate	35 fps (40 MHz) Standard clock 44 fps (50 MHz) Overclocked
Electron Full Well Capacity	40,000 e^-
Readout Noise	20 electrons
Dynamic Range	60dB
Output Format(s)	8, 12, 14-bit (single AD only)
Binning H/L	1x, 2x, 3x, 4x, 8x
Maximum Exposure	10 seconds
Minimum Exposure	50 μs
Shutter	Global

Trigger	
Inputs	External (TTL via IN1/IN2), software, computer
Options	Level, edge, pulse width, internal exposure
Modes	Free-run, standard, double, frame accumulation
Strobe Output	Programmable position and duration
Communication	
Interface	GigE
On Board Memory	None
Software Interface	ProAcquire
Lens Control	Available in ProAcquire (LC-2 integration)
Environmental	
Vibration/Shock	DIN EN 60068-2-64
Operating Temperature Range	0°C to 50°C
Humidity	20% to 80% non-condensing
Size & Weight	
Size	98.5 mm (L) x 29 mm (H), 44 mm (L)
Weight	220 grams
Lens Mount	c-mount
Power Requirements	
External Power Input	12-24 VDC
Power Consumption	4.9 W @ 12 VDC
Export	
ECCN	EAR99

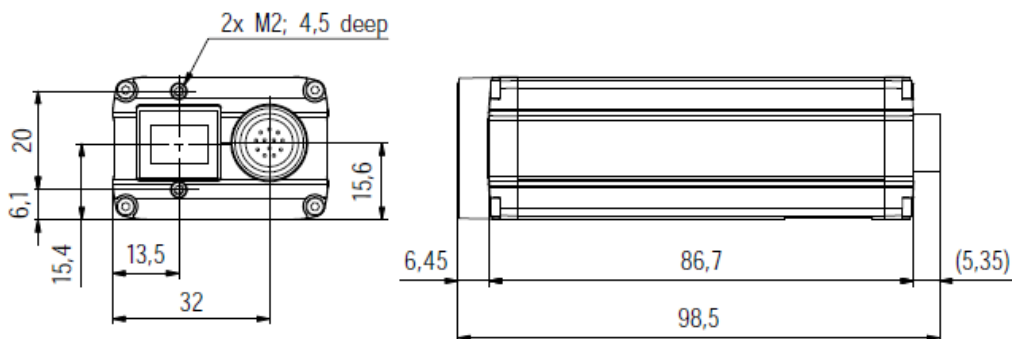

PSP-CCD-M Dimensions

Color CCD Camera

Product ID: PSP-CCD-C

The PSP-CCD-C is a 2-megapixel CCD color camera designed to operate within a PSP system. The camera is small and lightweight at 220g allowing for an array of cameras to be mounted in a tight place for larger scale models and applications. The PSP-CCD-C is used in Binary PSP and particle shadow velocimetry. One approach that allows binary pressure sensitive paint data to be acquired using a single camera involves the use of a color camera. Rather than use optical filters in front of the camera lens, the filtering is applied on the chip using a standard Bayer filter. In the case of BinaryFIB®, the pressure-sensitive signal is acquired on the red pixels and the reference signal is acquired on the green pixels. All images are acquired through a single camera and lens minimizing image alignment errors. This single chip system also accomplishes a second goal; all data is acquired simultaneously, and thus the stability of the illumination source is a less significant issue. The major drawback of this approach is the loss of spatial resolution. In a color chip, only ¼ of the pixels are sensitive to the signal channel (red pixels) on the standard Bayer filter. Despite the loss of spatial resolution, the color camera approach produces excellent results at low speeds. The normal frame rate is 35 fps but can operate at 44 fps in overclock mode. The camera features a software trigger and external TTL trigger over BNC. The camera is compatible with Windows 7, Vista and XP both 32- and 64-bit.

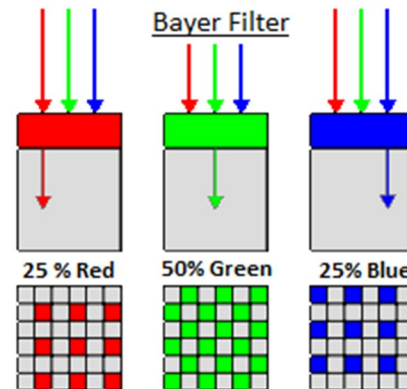
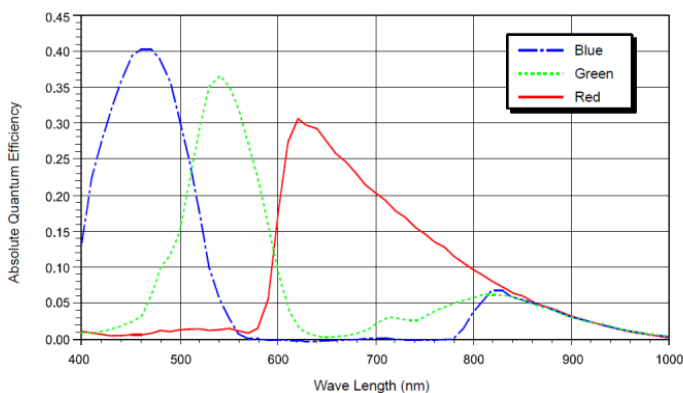

SPECIFICATIONS

Sensor	
Resolution	1600 x 1200 (active)
Type	KAI-2020 CCD
Format	11.89 mm (H) x 8.94 mm (V), 14.8 mm diagonal (1" optical format)
Pixel Size	7.4 μm
Frame Rate	35 fps (40 MHz) Standard clock 44 fps (50 MHz) Overclocked
Electron Full Well Capacity	40,000 e ⁻
Readout Noise	20 electrons
Dynamic Range	60dB
Output Format(s)	8-, 12-bit
Binning H/L	1x, 2x, 3x, 4x, 8x
Maximum Exposure	10 seconds
Minimum Exposure	50 μs
Shutter	Global

Trigger	
Inputs	External (TTL via IN1/IN2), software, computer
Options	Level, edge, pulse width, internal exposure
Modes	Free-run, standard, double, frame accumulation
Strobe Output	Programmable position and duration

Communication	
Interface	GigE
On Board Memory	None
Software Interface	ProAcquire
Lens Control	Available in ProAcquire (LC-2 integration)

Environmental	
Vibration/Shock	DIN EN 60068-2-64
Operating Temperature Range	0°C to 50°C
Humidity	20% to 80% non-condensing

Size & Weight	
Size	98.5 mm (L) x 29 mm (H), 44 mm (L)
Weight	220 grams
Lens Mount	c-mount

Power Requirements	
External Power Input	12-24 VDC
Power Consumption	4.9 W @12 VDC

Export	
ECCN	EAR99

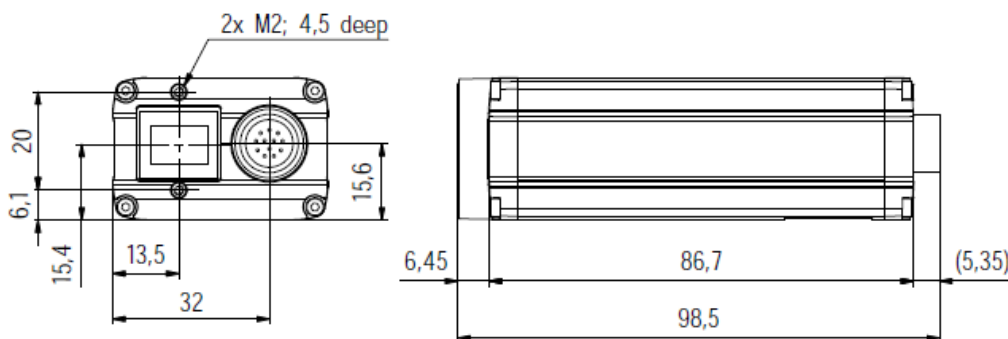

PSP-CCD-C Dimensions

4 | System integration

Communication between all components of a system is paramount to the operation of the system as a whole. Instrument control devices make operating large-scale integrated systems more time-efficient, expand their capability and reduce time needed on-condition or in the test facility in general. Small-scale systems also benefit from instrument control devices allowing for faster data acquisition.

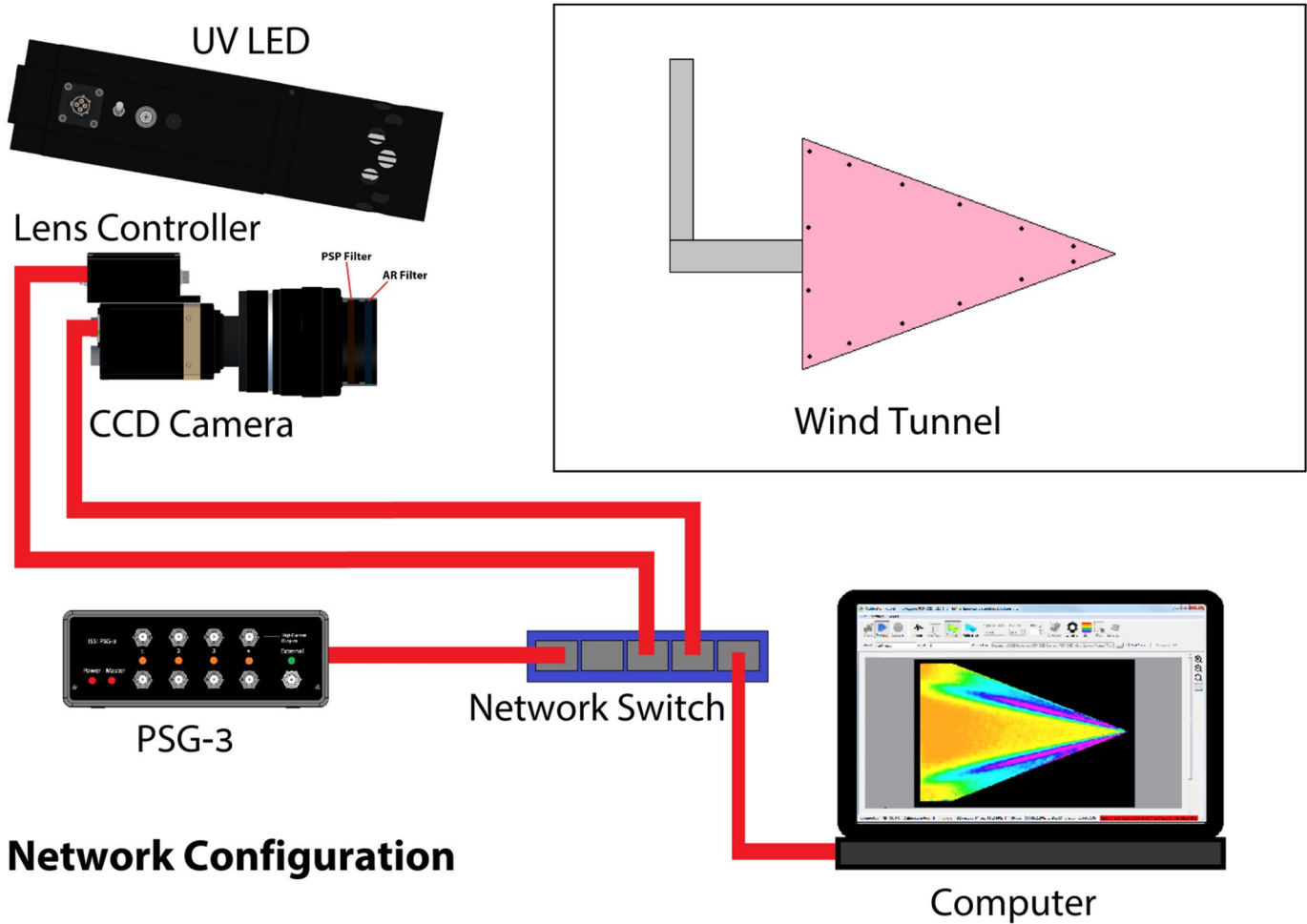

PSP and TSP data acquisition systems can communicate with the test facility and can be remotely operated from a control room after installation. Remote control of each component of the system saves one of the most expensive commodities in experimental or production testing: time. ISSI devices can all be operated over a network which also reduces the amount of cabling to be installed during a test. With each device being uniquely identifiable, a large-scale PSP/TSP test can be operated on a single computer or by a small data acquisition team.

Instrument Control

4.1 PULSE/DELAY GENERATOR

Product ID: PSG-3

The PSG-3 is a four-channel pulse/delay generator. It can be used as a master clock for timing and delay control. It can be externally triggered or gated by an external event. Pulse width, delay, repetition rate, and other timing parameters can be controlled by one of two available interfaces

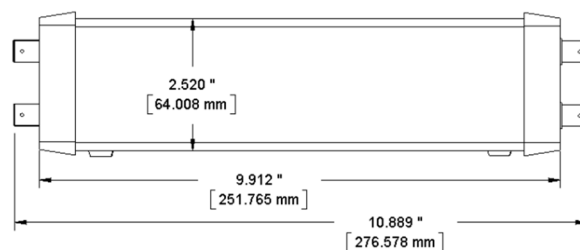
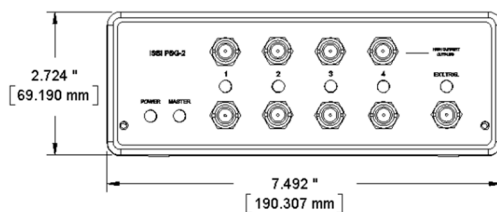

SPECIFICATIONS

I/O Configuration	
TTL Outputs	4 standard, 4 high-current (mirroring standard)
Inputs	1 Ext. Trig. Input 1 Inhibit
Divide-by-N	1 input, 1 output
Internal Generator	
Repetition Rate	0.100 Hz to 25.00 MHz
Resolution	20 nanoseconds
Burst Mode	1 – 131,072 pulses
Output Modes	Single-shot, burst, continuous
Master Clock	50 MHz, +/- 30 ppm Dual Clocks allow for independent repetition rates from one PSG-3
Timing Clock Settings	20-, 40-, 80-, 160-ns
Programming	
Control Mode	Internally triggered, externally triggered and/or gated. Generator 1 & 2 can be independently set to internally or externally triggered.
Multiplex	None
Divide-by-N	2-255

Trigger Input	
Threshold	0.05 - 5.0 V
Max Input Voltage	7.0 V
Max Input Frequency	5 MHz
Input Impedance	>1 M Ω
TTL Outputs	
Output Impedance	50 Ω
Output Voltage	@ 50 Ω : 2.5 V (Standard outputs) @ 1 K Ω : 4.0 V (High-current outputs)
Pulse Width	20 ns to 10.736 s
Delay Width	20 ns to 10.736 s
Rise Time	4 ns
Fall Time	4 ns
Communication Interfaces	
Ethernet	1 input, 10/100 Mbps
USB 2.0	1 input, type B
RJ-11	2, sync in and sync out (Master/slave configuration.)
Power Input	
External Power Input	85-264 VAC, 50-60 Hz
Export	
ECCN	EAR99

4.2 MOTORIZED ZOOM LENS CONTROLLER

Product ID: LC-1

The CCTV Lens Controller (LC-1) is a control device for motorized zoom lenses with motorized iris. The LC-1 can operate lenses with up to three motors with or without potentiometers. The Ethernet connection makes communication much simpler than traditional serial lens controllers and also allows it to be operated over a longer distance than serial devices. Not compatible with auto-iris.



- Remotely control lenses with 9-12V motors
- Interface for 10/100 Mbps Ethernet
- Multiple devices can be connected and simultaneously controlled over a network
- Easy to use software interface or API commands
- Unlimited programmable preset capability to easily store and recall saved positions on the lens
- Keyed connection for lens communication

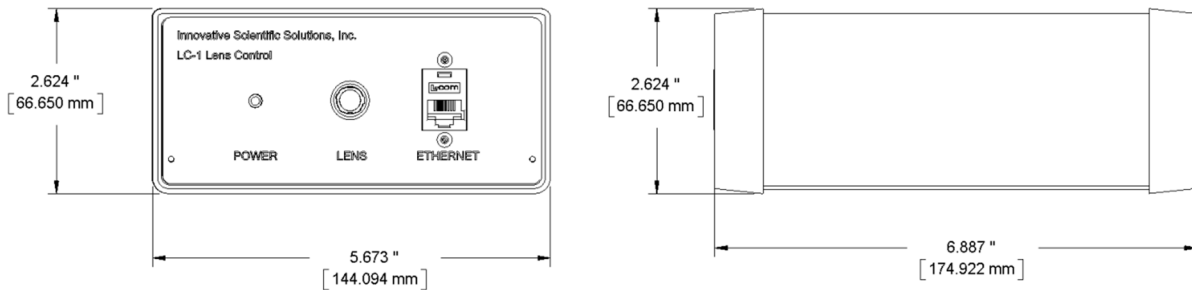

Uses for this device include Closed-circuit television systems (CCTV), event monitoring, machine vision, and optical based measurements in wind tunnels or other large test facilities.

****Lens not included****

SPECIFICATIONS

Power	100-240 V, 50-60Hz, 0.3A
Lens Voltage Range	9-12V
Operating Temperature	2-60 °C
Interface	10/100 Mbps Ethernet
Lens inputs	1
Presets	Unlimited, programmable
Software	Windows GUI, TCP/IP API
ECCN	EAR99

4.3 MOTORIZED ZOOM LENS CONTROLLER

(Product ID: LC-1S)

The Motorized Zoom Lens Controller (LC-1S) is a compact controller for CCTV lenses. The LC-1S can operate lenses with up to three motors with or without potentiometers as well as auto-iris lenses with DC or Video iris.

- Remotely control motorized zoom lenses (6-16V) with auto-iris (DC and Video type)
- Interface for 10-100 Mbps Ethernet
- Multiple devices can be connected and simultaneously controlled over a network
- Easy to use software interface or API commands
- Unlimited programmable preset capability to easily store and recall saved positions on the lens
- Keyed connection for lens communication

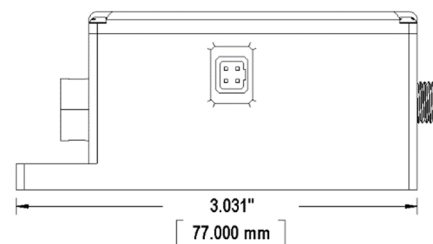
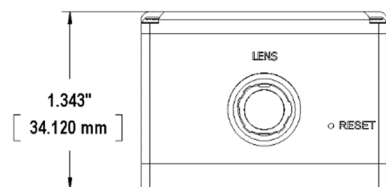

Uses for this device include Closed-circuit television systems (CCTV), event monitoring, machine vision, and optical based measurements in wind tunnels or other large test facilities.

****Lens not included****

SPECIFICATIONS

Power	100-240 V, 50-60Hz
Input	6.5-28VDC, 0.75A (nominal)
Lens Voltage Range	6-16V (Set based on lens)
Operating Temperature	2-60 °C
Interface	10/100 Mbps Ethernet
Lens inputs	1
Presets	Unlimited, programmable
Software	Windows GUI, TCP/IP API
ECCN	EAR99

4.4 EF/EF-S LENS CONTROLLER

Product ID: Controller: LC-2, Adapters: LC-2A-C, LC-2A-M42, LC-2A-T, LC-2A-T18, LC-2A-M58-75

The Canon® EF/EF-S Lens Controller is small and compact and can operate most Canon® (USM), Sigma® (HSM) and Tamron® (USD) EF/EF-S lenses including L series and both APS-C and full-frame models, with and without image stabilization. The controller is paired with an appropriate lens adapter to communicate with a lens.



- Accurate control of Focus, and aperture
- Auto-detection of attached lens and F-number with included LC-2A lens adapter for C-, T-, M42 or M58x0.75 mounting.
- Interface for 10/100 Mbps Ethernet
- Integrate with API command structure
- Multiple devices can be connected and simultaneously controlled over a network
- Unlimited programmable preset capability to easily store and recall saved positions on the lens

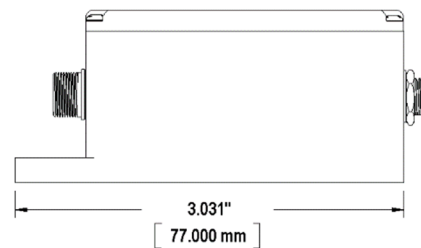
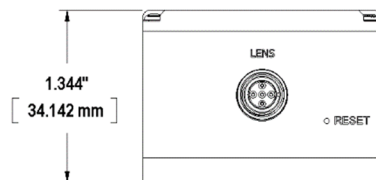

****Lens not included****

SPECIFICATIONS

Power	100-240 V, 50-60Hz
Input	6VDC, 1.5 A
Lens Voltage Range	9-16V
Operating Temperature	2-60 °C
Interface	10/100 Mbps Ethernet
Lens inputs	1
Lens Adapter	C, M42, T, M58x0.75
Presets	Unlimited, programmable
Software	Windows GUI, TCP/IP API
ECCN	EAR99

Lens Adapter Models

Standard lens mounts are available for the adapters. For cameras with non-standard mounts, customization of the lens adapter is available at an added cost. If the flange focal distance does not equal 44.0 mm with the lens adapter and camera, a separate adapter will be needed or a custom lens adapter will need to be constructed.



EF-c Lens Adapter (LC-2A-C)

A popular mount for lower resolution image sensors, the c-mount is a 25 mm threaded optics mount. The front side of the adapter features an EF adapter ring to lock the lens in place and pins to make contact with the pads on the lens. The back side is a male c-mount threaded screw mount which threads directly into a camera lens mount.



EF-M42x1 Lens Adapter (LC-2A-

A popular mount for medium to high resolution image sensors, the M42-mount is a 42 mm threaded optics mount. The front side of the adapter features an EF adapter ring to lock the lens in place and pins to make contact with the pads on the lens. The back side is a male M42x1.0 metric threaded screw mount which threads directly into a camera lens mount.



EF-M42x0.75 Lens Adapter

The "T" mount is a common lens mount for astronomy cameras and other optical assemblies. The front side of the adapter features an EF adapter ring to lock the lens in place and pins to make contact with the pads on the lens. The back side is a male M42x0.75 metric threaded screw mount which threads directly into a camera lens mount. Also available in short 18mm thickness (LC-2A-T18).



EF-M58x0.75 Lens Adapter (LC-2A-

The M58 adapter is used on cameras with large format, high-resolution imaging sensors. The front side of the adapter features an EF adapter ring to lock the lens in place and pins to make contact with the pads on the lens. The back side is a male M58x0.75 metric threaded screw mount which threads directly into a camera lens mount.



4.5 PSP/TSP Calibration System

Product ID: CAL-04, CTC-04

The PSP/TSP calibration system is a multi-function system designed for controlling the mass-flow of two gases and temperature within a sealed cell. This evolution of ISSI's pressure and temperature sensitive paint calibration system utilizes a gas flow design whereby the nitrogen to oxygen mass flow ratio is controlled to simulate pressure. The advantage of this technique is the ability to simulate pressures from approximately 0 to 4.0 bar without the noise and complexity of the diaphragm pump. Nitrogen and oxygen from gas bottles flow into the gas inlet fittings on the calibration box via appropriate dual stage regulators. The mixed gas exits the calibration system box via the output rear fitting and then into the calibration head where the gas flows over the sample. The temperature control has been upgraded to provide faster temperature control and improved stability. All of the displays are backlit and colored for ease of recognition.



Calibration Control System (CAL-04)



Calibration Cell (CTC-04)

SPECIFICATIONS

Power	100-240 V, 50-60Hz
Interface	10/100 Mbps Ethernet
Pressure Range	0.0 - 4.0 bar
Temperature Range	0 – 70 °C
Pressure Accuracy	0.5% of full scale
Temperature Accuracy	0.1 °C
Software	PT Control (Windows 7, 10)
Warranty	1 year
ECCN	EAR99

****ISSI does NOT supply bottle gas or regulators****

4.6 PSP/TSP Optics

Optical kits include all filters and lenses necessary for PSP and TSP measurements. Each paint requires a specific wavelength filter to separate the LED excitation from the PSP/TSP emission before the signal enters the camera lens. Optical kits are available for c- and EF-mount lenses.

Product ID: OP-K-C

The c-mount optical kit contains three c-mount lenses to be used on the PSP-CCD-C and PSP-CCD-M cameras. The kit also contains all appropriate filters corresponding to the paints in the PSP-K pressure sensitive paint kit.



Product ID: OP-K-EF

The Canon® EF optical kit contains two Canon® EF lenses to be used on the PSP-CCD-C and PSP-CCD-M cameras. The kit also contains all appropriate filters corresponding to the paints in the PSP-K pressure sensitive paint kit.



5 | Molecular Iodine Vapor Reference Cells

Molecular iodine cells are used in spectroscopic applications, precise wavelength calibration and as a frequency reference. The spectrum of molecular iodine includes discrete rotational and vibrational bands with very fine structure in the visible (490-650 nm) spectrum. More recently, iodine has been used as frequency discriminators in Planar Doppler Velocimetry (PDV) and Filtered Rayleigh Scattering (FRS) systems. When used in PDV/FRS systems, the stability of the iodine cell transmission-vs-frequency profile has been identified as a significant source of error. This instability is caused by variations in the iodine number density. The number density (pressure) of the iodine vapor is a strong function of temperature, and therefore, small changes in cell temperature (~0.1 °C) can have significant impact on the transmission-vs-frequency profile.

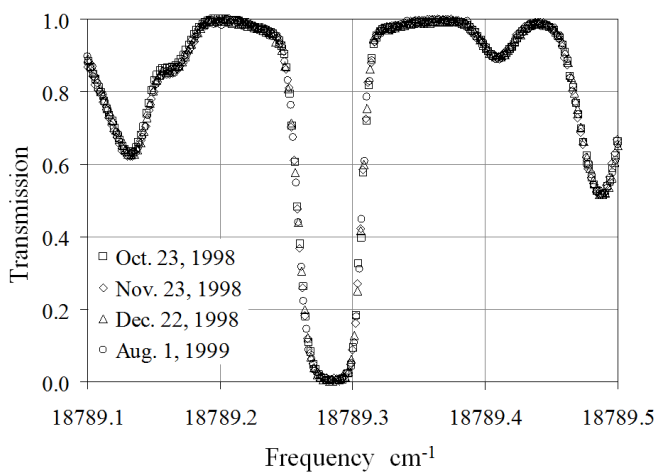
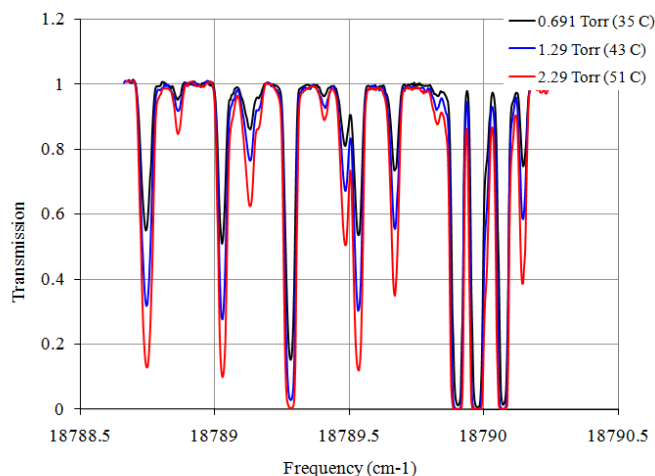

Planar Doppler Velocimetry (PDV, also known as Doppler Global Velocimetry, DGV) is an image-based technique that is capable of producing three component velocity measurements in a plane. With PDV, one measures the Doppler shift of light scattered by seed particles in the flow, similar to LDV. To perform PDV, the flow is seeded with scattering particles and a laser sheet is used to illuminate the interrogation region. The interrogation region is imaged through molecular absorption filters by several CCD cameras and the images are post-processed using a set of calibration images to determine velocities. With PDV, one measures the Doppler shift of light scattered by seed particles in the flow, similar to LDV. The Doppler shift is dependent on the incident light wavelength, the velocity of the scattering particle, and the observation and incident light directions. With LDV, the Doppler shift is determined using heterodyne detection of the beat frequency between the incident and scattered (Doppler shifted) light. For PDV, a molecular or atomic vapor filter is used as the frequency discriminator.

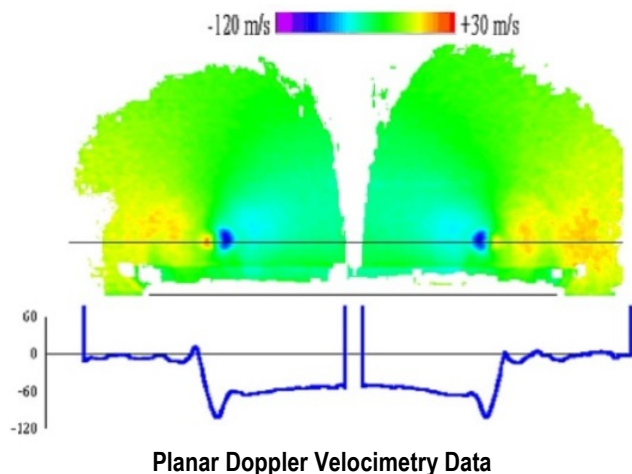

5.1 Permanently Sealed Molecular Iodine Cell

Product ID: I2S-5, I2S-10

To create the permanently sealed starved cell, the cell is evacuated and cold-finger filled with iodine is brought to the desired vapor pressure (cold-finger operating temperature). The stem between the cold-finger and cell is then permanently sealed with a torch, isolating the iodine in the cell body and fixing the number density. The cell is then operated 10-20 °C above the cold-finger set temperature and the iodine in the cell is a super-heated vapor with a set number density. The result is a molecular cell with a very stable absorption spectra.

Permanently sealed iodine-vapor cells are 3-in.-dia, 5-in.-long or 10-in.-long Pyrex cells. These cells are manufactured with a prescribed iodine partial pressure (specified by user at time of order). In addition, the transitions can be pressure broadened with nitrogen partial pressure (specified at time of order).



Standard Sealed Unit Includes:

1. Pyrex cell with optical-grade Pyrex windows.
2. Anodized-aluminum housing with post-mounting surface and 1/4 -20 threaded holes.
3. Heating mat and one type-K thermocouple.
4. Insulation to limit heat transfer to aluminum housing.
5. Absorption scan to document iodine conditions.



SPECIFICATIONS FOR I2S-5 & I2S-10

Length	125mm, 250mm
Diameter	76mm
Housing	Anodized Aluminum
Mounting	¼"-20 Threaded
Maximum Operating Temperature	130 °C
Thermocouple	Type T
Set Point	30 °C – 50 °C
Warranty	1 year
ECCN	EAR99

5.2 Manifold Molecular Iodine Cell

Product ID: I2M-5, I2M-10

To create a sealed starved cell with a flexible set point, a glass cell with an attached cold-finger and vacuum port is constructed. The vacuum port and cold-finger include stopcocks. The cell is evacuated and cold-finger filled with iodine is brought to the desired vapor pressure (cold-finger operating temperature). The stem between the cold-finger and cell is then closed by closing the stopcock, isolating the iodine in the cell body and fixing the number density. The cell is then operated 10-20 °C above the cold-finger set temperature and the iodine in the cell is a super-heated vapor with a set number density. The result is a molecular cell with a very stable absorption spectra.

Iodine-vapor cells with a manifold are 3-in.-dia, 5-in.-long or 10-in.-long Pyrex cells. Standard cells are manufactured with 1/4 gm of iodine (actual pressure determined by temperature of water-cooling jacket at the time of operation). In addition, transitions can be pressure broadened with buffer gas supplied by user through a fill-port.



Standard Manifold Unit Includes:

1. Pyrex cell with optical-grade Pyrex windows.
2. Anodized-aluminum housing with 1/4 -20 mounting holes.
3. Water-jacketed iodine reservoir with Teflon valve.
4. Evacuation/fill port with Teflon valve.
5. Cell-heating mat, manifold-heating mat, and two type-K (or user-specified) thermocouples.
6. Two 1/4 -in.-tubing fittings for connection to temperature-controlled water source (user supplied).
7. One 1/4 -in.-tubing fitting for evacuation and buffer-gas (user supplied) filling.
8. Insulation to limit heat transfer to aluminum housing.



SPECIFICATIONS FOR I2M-5 & I2M-10

Length	125mm, 250mm
Diameter	76mm
Housing	Anodized Aluminum
Mounting	1/4"-20 Threaded
Maximum Operating Temperature	130 °C
Thermocouple	Type T
Set Point	30 °C – 50 °C
Warranty	1 year
ECCN	EAR99

6 | Software

6.1 ProAcquire PSP/TSP Acquisition Software

Product ID: OMS-30a

ProAcquire is an image acquisition software for PSP and TSP measurements. ProAcquire is compatible with PSP-CCD series cameras. Cameras, LEDs, pulse generators and lens controllers can be controlled from multiple viewing angles over a local network. The standard version of ProAcquire operates with ISSI cameras, lamps, lens controllers, and pulse generators.

ProAcquire enables three separate operating modes of the camera: 1.) Radiometric acquisition (also referred to as "intensity mode"), 2.) Lifetime Accumulation mode and 3.) Single-Shot Lifetime acquisition.

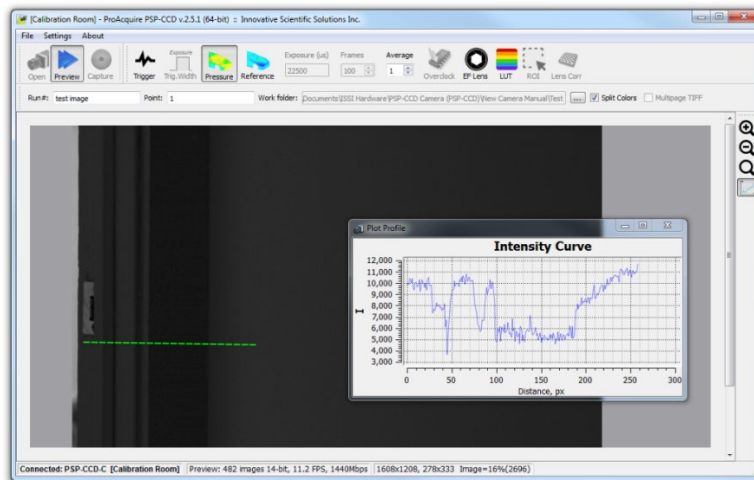

ProAcquire User Interface

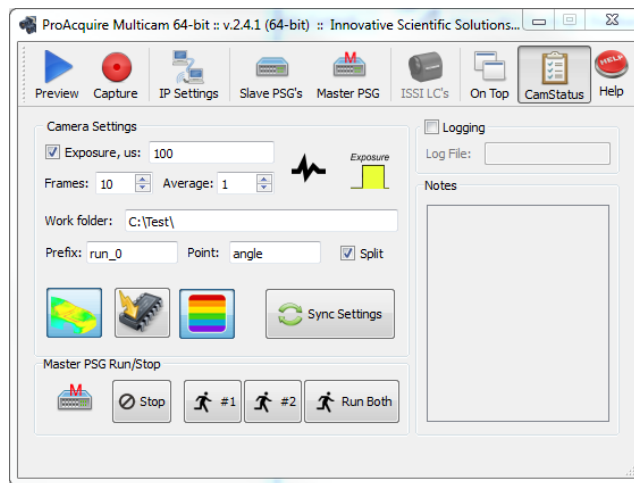

ProAcquire Multi-Camera Acquisition

Data taken in ProAcquire is stored as a 12- or 14-bit .TIFF file which can be opened by either: Prolmage, OMS-Lite, ImageJ or Matlab. For a detailed explanation of the features of ProAcquire, please see the user manual.

6.2 OMS-Lite Beginner PSP/TSP Post-Processing Software

Product ID: OMS-Lite

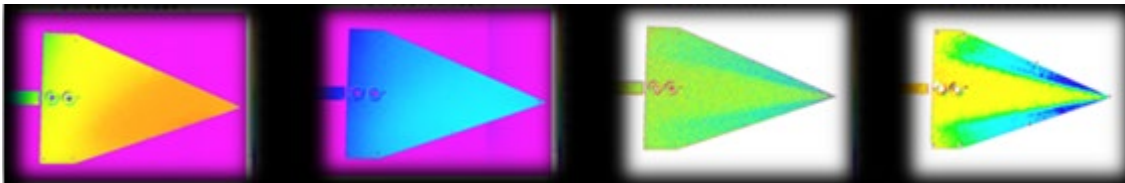

OMS-Lite is a beginner version of our OMS Prolmage package. OMS-Lite supports GUI-based PSP/TSP data processing in an interactive mode. The data reduction procedure for PSP involves taking the ratio of wind-off / wind-on images and converting this image to pressure using a calibration that relates this ratio to pressure. In practice, several other image processing steps are often required. These steps can include compensating for the background lighting, image alignment, image filtering, in-situ calibration, temperature correction, and resection (transformation of 3-D model coordinates into 2-D image coordinates), all of which are supported by OMS-Lite. The user interface allows the user to load the relevant wind-off and wind-on data files, and to access any of the image processing and calibration features.

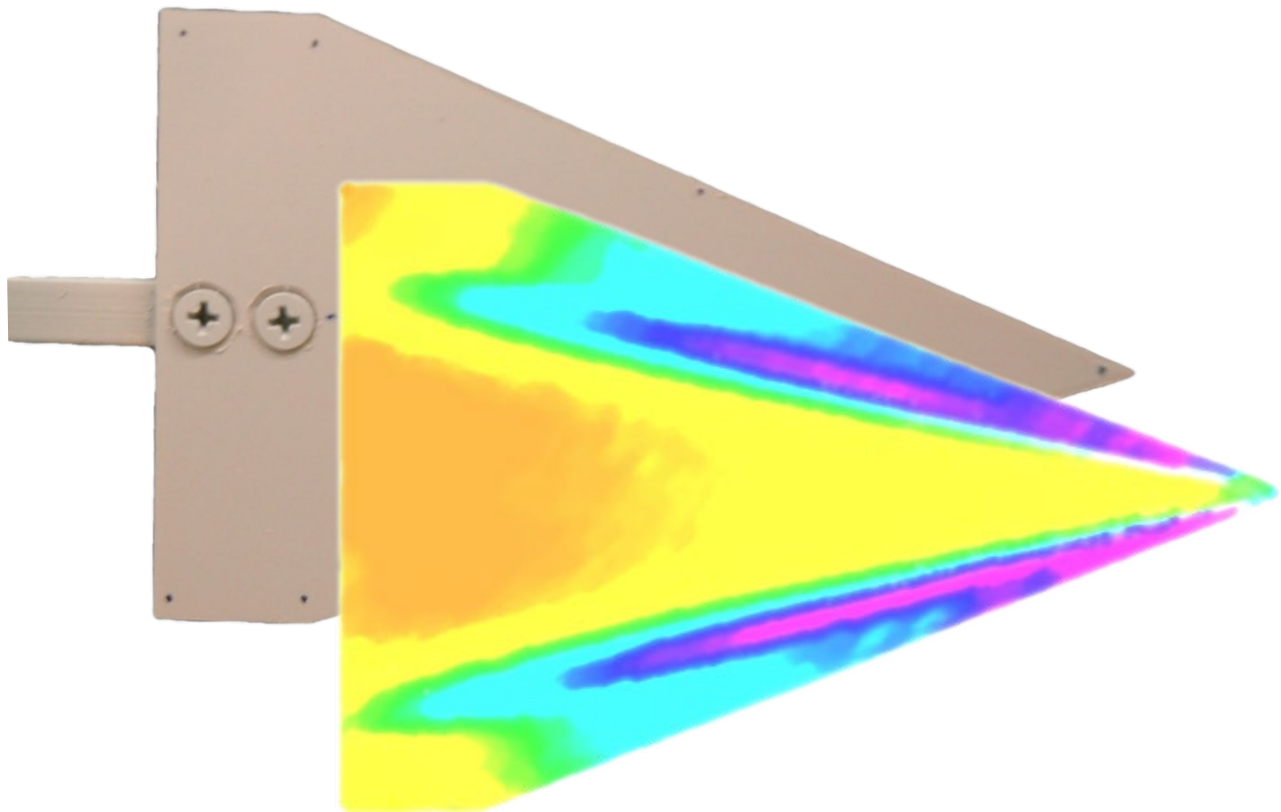

6.3 OMS-Prolmage Advanced PSP/TSP Post-Processing Software

Product ID: OMS-Lite

Prolmage is a data processing software developed for higher-end users for experiments with multiple cameras and test conditions. Prolmage includes many image editing and data processing tools that the basic OMS-Lite does not. A region of interest can be selected and cleaned up in Prolmage to produce high-quality pressure or temperature fields.

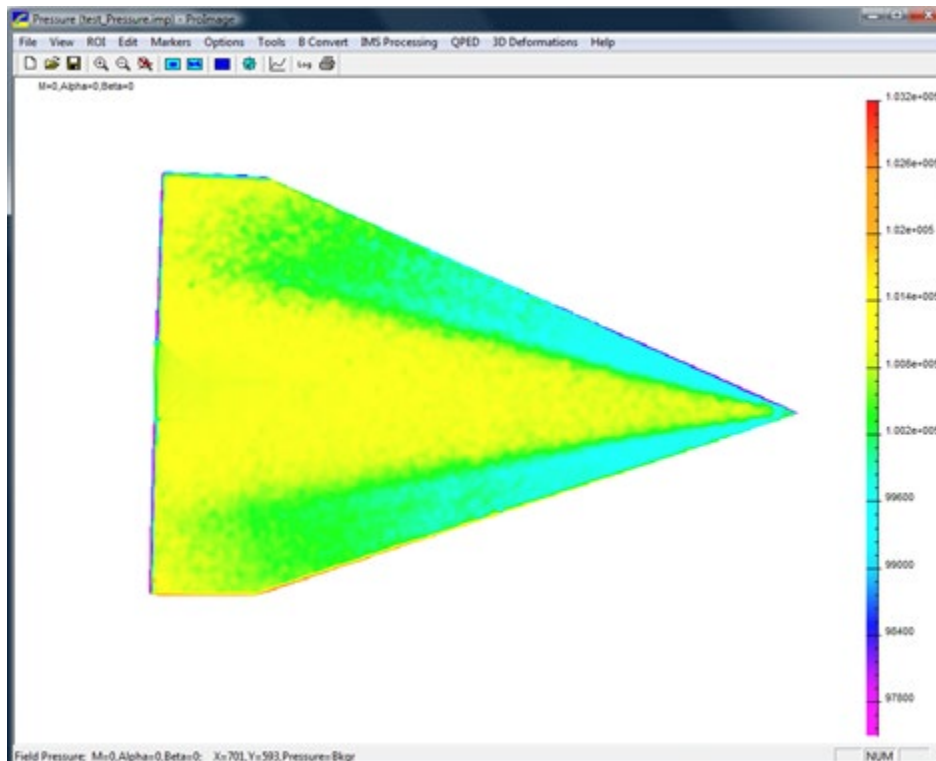

Pressure Over Surface of Delta Wing in Prolmage

Many additional features are available in Prolmage to clean up images. Imperfections such as screw holes, markers, and paint imperfections can be removed from the field.

7 | Packaged Systems

Pressure and Temperature Sensitive paint is more than just the paint itself. Using the correct hardware is paramount to the success of the test. ISSI packages hardware and software with the appropriate paint to create a customer-tailored measurement system.

7.1 Small-Scale Academic PSP/TSP Systems

The educational PSP/TSP system provides everything needed to get started with PSP and TSP. This system provides high spatial resolution, excellent dynamic range, but lower data capture rates than our higher-end systems. For applications where time in the wind tunnel is not a critical issue, it represents an excellent cost/performance trade-off. This system provides full capability for undergraduate demonstrations, training, and laboratory exercises. It will support all but the most demanding graduate and faculty research programs requiring distributed pressure and temperature measurements in wind tunnel environments. The system employs proven ISSI LED technology for excitation of the luminous probes in the paints. The camera is based on a color CCD chip, eliminating the need for a filter wheel when using bi-luminophore paints. The OMS-Lite software package is easy to use and fully supports the educational and research capabilities of the PSP/TSP system.

Components Include:

- Color CCD Camera
- Continuous 2-inch air-cooled LED for PSP/TSP
- Parabolic Reflector and Diffusor
- Pulse/delay generator
- Pressure and Temperature Sensitive Paint Starter Kit
- Optical kit with lenses and appropriate long-pass filters for PSP/TSP
- Wing models
- OMS-Lite single-user license

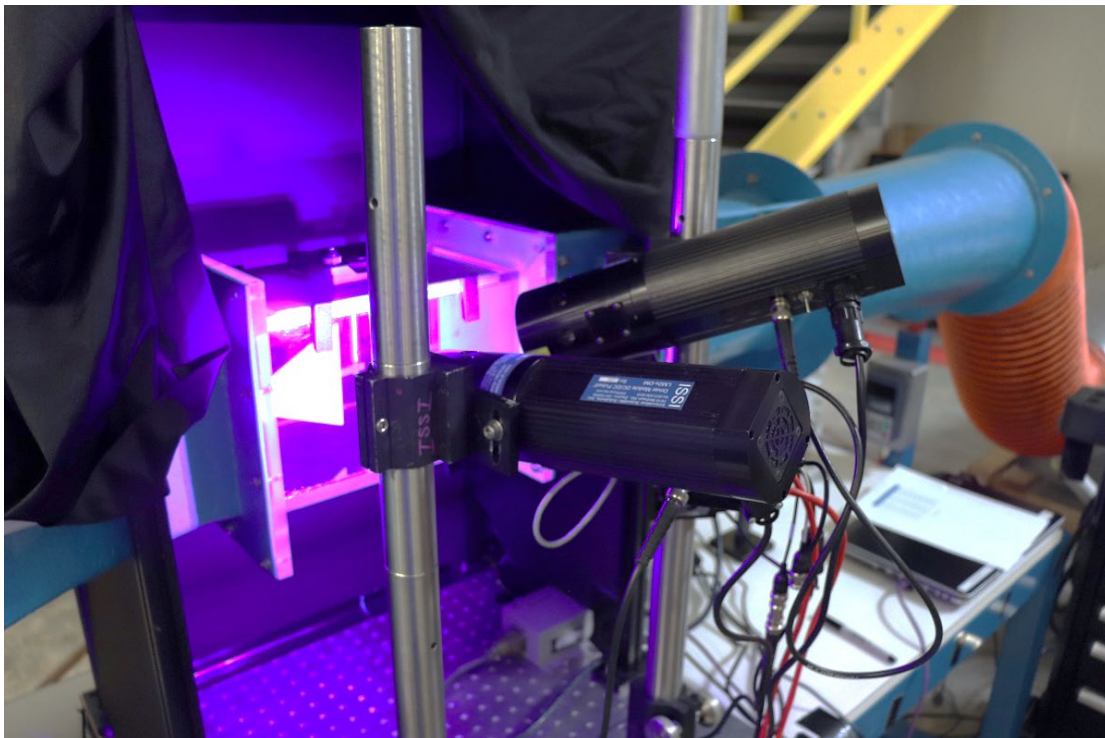

7.2 Large-Scale Commercial PSP/TSP Systems

The distinction from the small-scale system is the level of integration and number of components. Large-scale PSP/TSP systems have been deployed in many transonic and low-speed wind tunnels around the world.

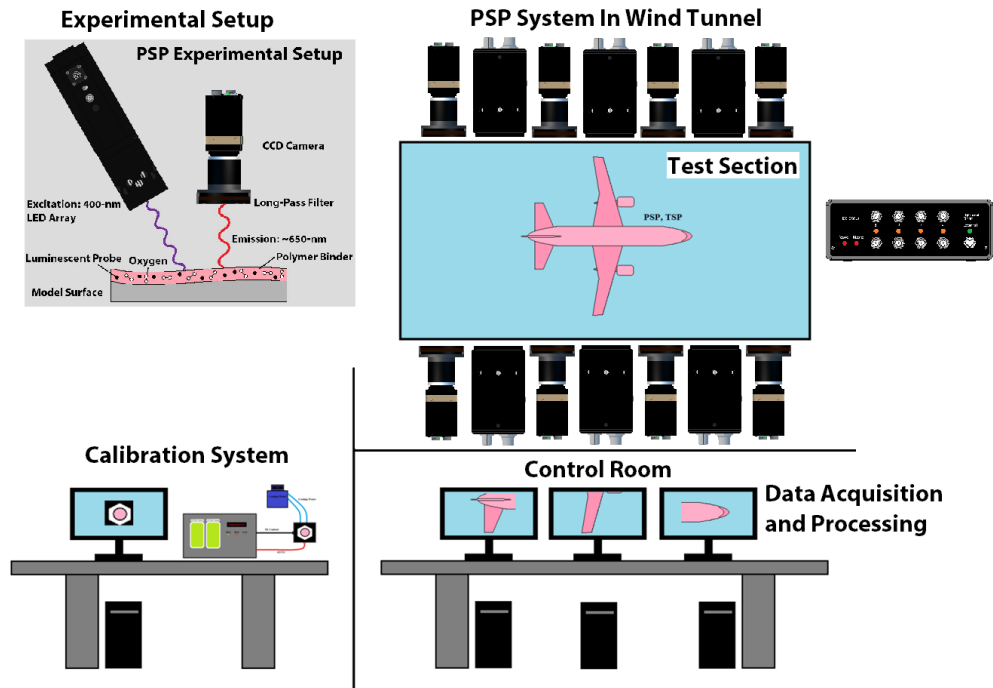

A large-scale production test typically will involve multiple cameras and LEDs to capture the entire surface of the model. The images from each camera are stored on a master PC for post-processing. The individual images are then stitched together to create the entire model surface. Systems such as this are integrated into the tunnel and move with the model as it changes yaw or angle of attack.

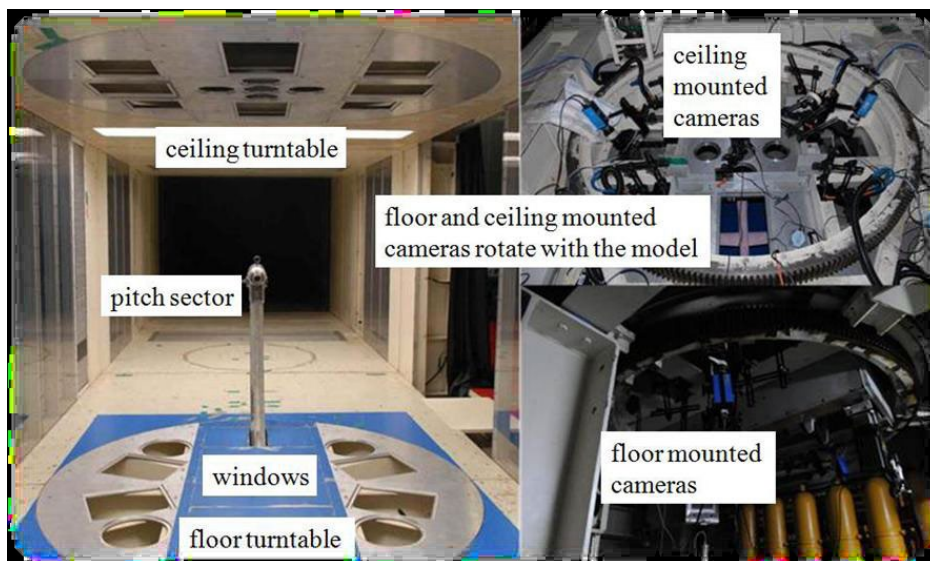

Components May Include Multiples of:

- PSP-CCD-C/M Color CCD Camera
- 2-inch air-cooled LED for radiometric PSP/TSP
- 4-inch air-cooled LED for radiometric PSP/TSP
- 2-inch water-cooled LED for radiometric PSP/TSP
- 3-inch vortex-cooled LED for radiometric PSP/TSP
- PSG-3 Pulse/delay generator
- PSP-K Pressure and Temperature Sensitive Paint starter kit
- OP-K Optical kit with lenses and appropriate long-pass filters for PSP/TSP
- SYS-BOX containing PSP/TSP acquisition hardware
- LC-1S Ethernet based lens controller for remote focus zoom lens (large facilities)
- LC-2 Ethernet based lens controller for EF/EF-S lenses
- Full OMS post-processing software package
- Multi-camera control acquisition software

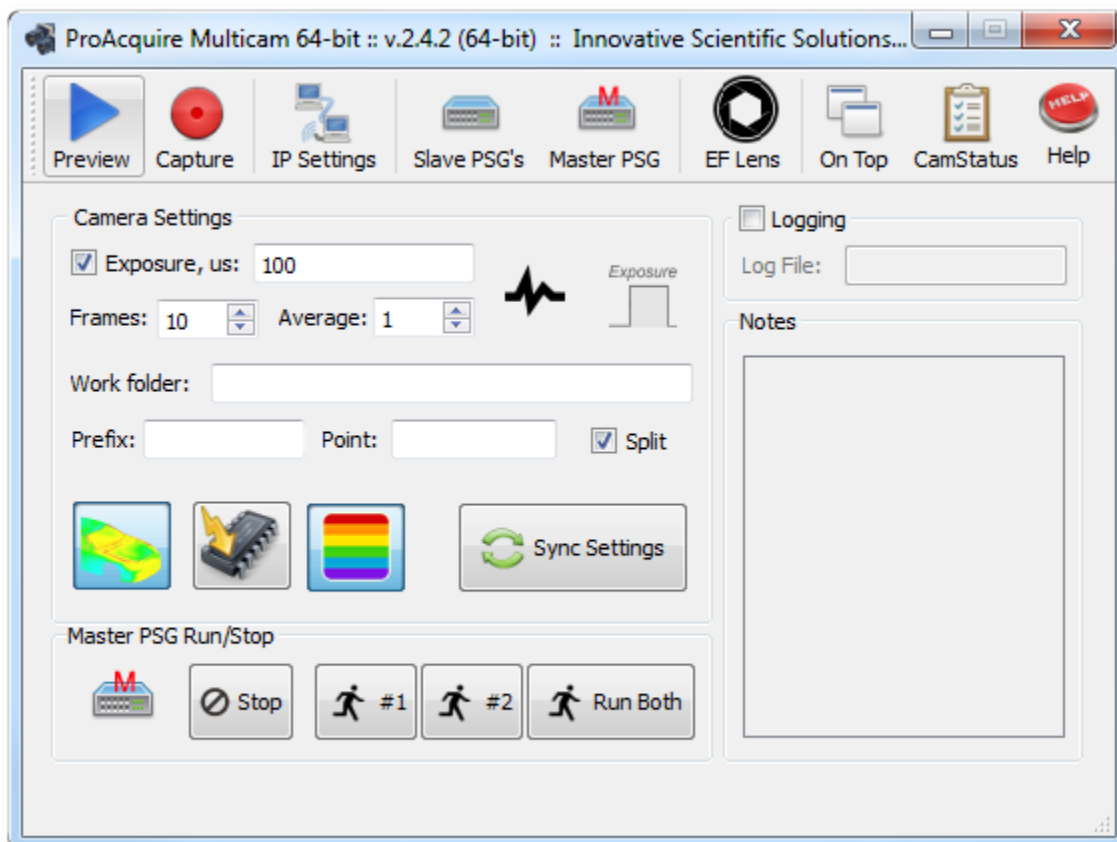
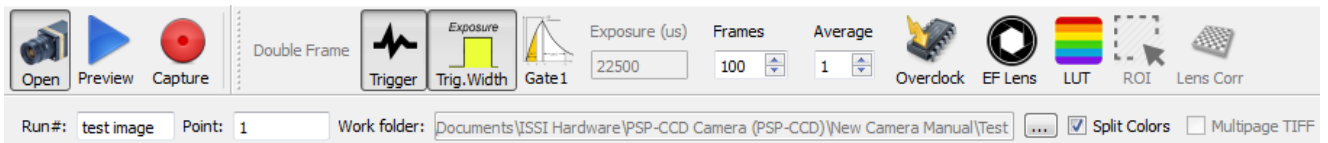

8 | Surface Stress Sensitive Film

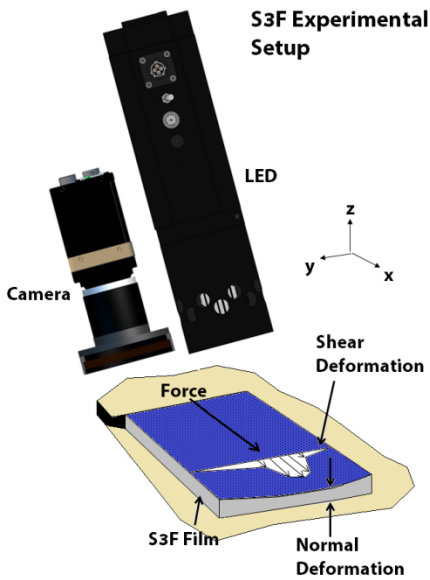

Shear Stress Sensitive Film (S3F) is an elastic polymer film embedded with a fluorescent dye and coated with surface markers. The film is illuminated with an LED light source to excite the dye and surface markers. The surface is imaged with a scientific camera to monitor deformation of the layer due to shear and normal forces. The film is imaged unloaded and then loaded to compare the difference in normal force and shear. Shear is measured by tracking the movement of the surface markers within the film (of known shear modulus and thickness) resulting from an applied tangential load. The technique is similar to PIV for shear measurements for particle tracking. Upon removal of the load, the film returns to its original form.

Normal forces are measured by the differing fluorescent dye concentrations (intensity levels) due to normal force loading where pressure gradients are produced. As the film is loaded, it deforms locally and therefore less dye is present in that area. The film cannot be used to measure changes in static pressure, only pressure gradients, which means it is insensitive to static pressure changes. Therefore, the film experiences minimal crosstalk between shear and normal force measurements.

Applications for S3F range from insect locomotion to biomedical analysis of the human gait to automobile and aircraft tire rollover and even hydrodynamic applications. The polymer layer can be tuned to a specific shear modulus to allow the sensor to operate over specific ranges depending on the application.

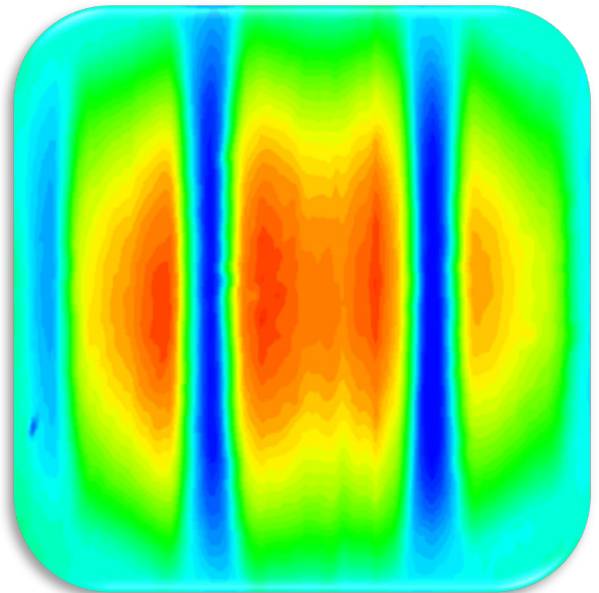
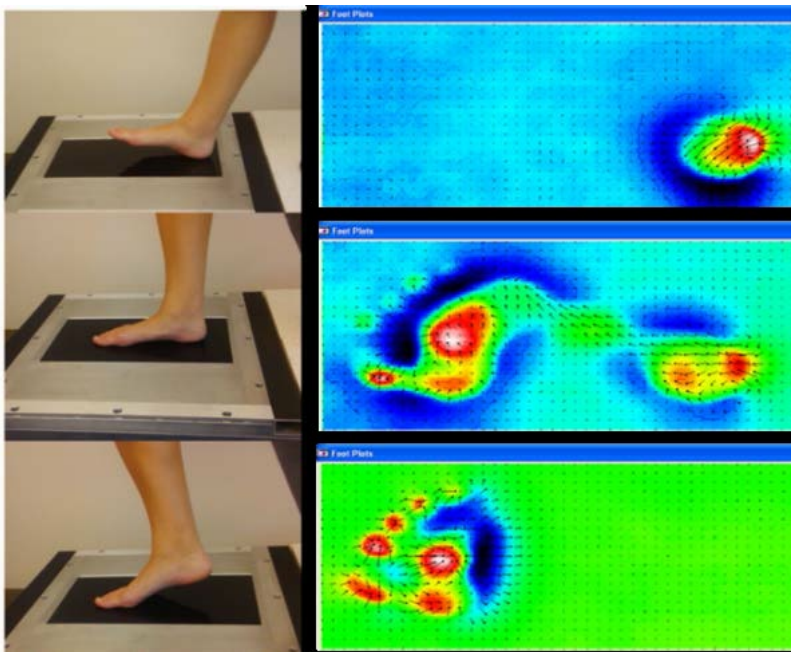

FootSTEPS Gait Analysis Sensor System (Left), Aircraft Tire Footprint from Aircraft Tire S3F System (Right)

8.1 Miniature S3F Sensor System

Product ID: FTS3F-DM

The miniature S3F system is a small packaged S3F imaging system for measuring shear and normal contact pressure of an object moving along the surface. It utilizes a high-resolution camera and built-in LED array to image a Surface Stress Sensitive Film (S3F) layer, polymerized on a glass window. The S3F layer contains a probe material that enables changes in film thickness, produced primarily by pressure, to be visualized as changes in illumination level. The mathematical ratio of loaded and unloaded images quantifies the vertical displacement of the film.

The system features an active measurement area of 2.5 x 2.5 inches with a spatial resolution of 0.2 mm. The size makes the system ideal for small scale testing of insects or small animal/reptile footprint measurements. The S3F layer can be made to a specified shear range for different applications. The interchangeable top window frame can be purchased separately if additional layers with differing shear and pressure ranges are required.

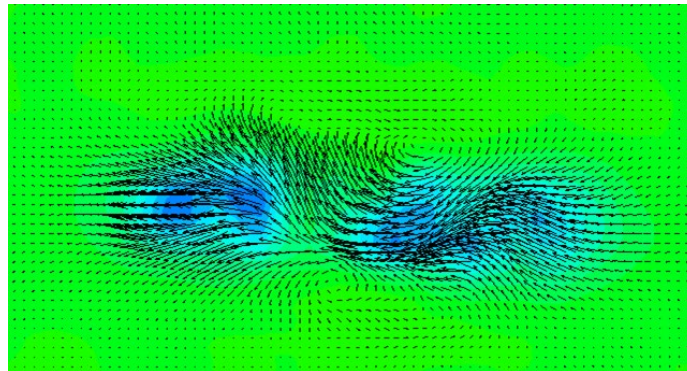
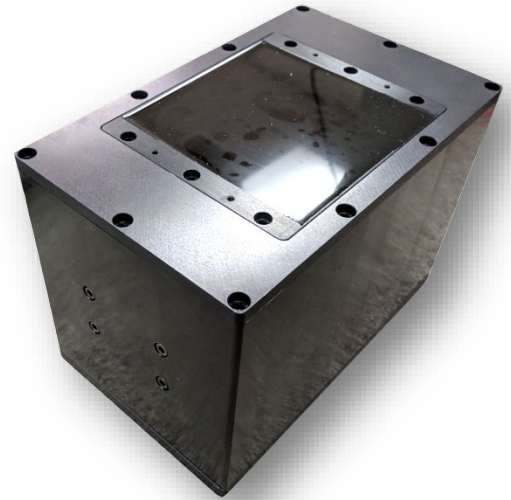

Shear Vectors from Spider Footprint on Miniature S3F System

Power	110-240 VAC, 50-60 Hz
Interface	USB 3.0
Linear Pressure Range	15-700 kPa. Unsaturated response over 2,000 kPa.
Linear Shear Range	3 to ±100 kPa. Also not the saturation point.
Accuracy	±5% of full scale for both pressure and shear
Data Capture Rate	15 fps
Spatial Resolution	0.2 mm
Crosstalk	Less than 3% between pressure and shear
Active Measurement Area	5 cm x 5 cm (2.5 in x 2.5 in)
Size	12.7 cm (L) by 20.3 cm (W) by 13.9 cm (H) (5 in by 8 in by 5.5 in)
Weight	4.6 kg (10 lb)
ECCN	EAR99

8.2 Intermediate S3F Sensor System

Product ID: IMS3F-1

The Intermediate S3F Sensor System utilizes a high-resolution camera to image ISSI's Surface Stress Sensitive Film (S3F) layer, polymerized on a glass window. This serves as a sensor for smaller applications such as insect and reptile gait studies as well as small areas of the body and small tire applications.

The S3F layer contains a probe material that enables changes in film thickness, produced primarily by pressure, to be visualized as changes in illumination level. The mathematical ratio of loaded and unloaded images quantifies the vertical displacement of the film.

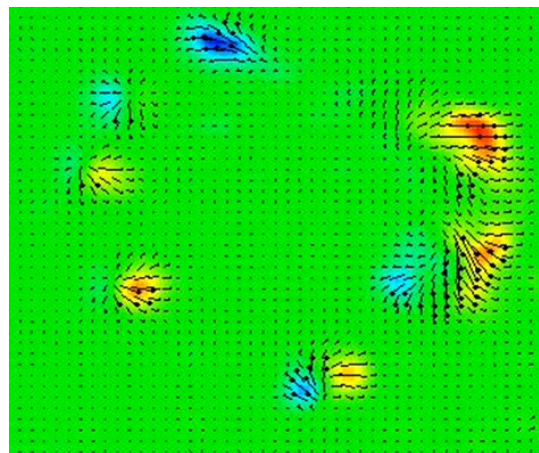

Shear Vectors from a Subject Hand on Intermediate S3F System

Power	110-240 VAC, 50-60 Hz
Interface	USB 3.0
Linear Pressure Range	15-700 kPa. Unsaturated response over 2,000 kPa.
Linear Shear Range	3 to ± 100 kPa. Also not the saturation point.
Accuracy	$\pm 5\%$ of full scale for both pressure and shear
Data Capture Rate	60 fps
Spatial Resolution	1.2 mm
Crosstalk	Less than 3% between pressure and shear
Active Measurement Area	20.3 cm x 30.5 cm (8 in x 12 in)
Size	40.6 cm (L) by 40.6 cm (W) by 42 cm (H) (16 in by 16 in by 16.5 in)
Weight	34 kg (75 lb)
ECCN	EAR99

8.3 FootSTEPS Gait Analysis Sensor System

Product ID: FS3F-1

The FootSTEPS system is used to conduct gait analysis of the human foot. One area of interest in gait analysis is related to ulcer formation in diabetic feet. Peak plantar pressure has been used as a predictor of ulcer formation in the past but studies have yielded only moderate correlations between diabetic foot ulcers and peak plantar pressure. Plantar shear is being investigated as a source of ulcer formation and only FootSTEPS provides the capability and resolution necessary to conduct both plantar shear and peak plantar pressure studies simultaneously.

Why FootSTEPS?

High-resolution visualization of plantar interactions with the ground will help to evaluate pressure and shear data at specific plantar locations during gait. The information gained from studies using FootSTEPS for diabetic patients may help to predict skin breakdown and ulcer formation. Custom orthotics can be designed specifically for each patient to mitigate development of ulceration or tissue breakdown in the foot.

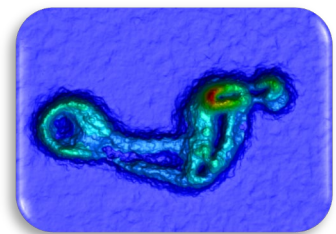
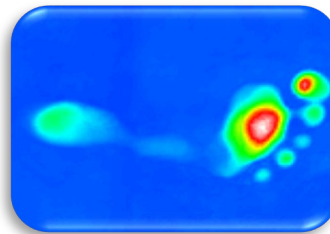
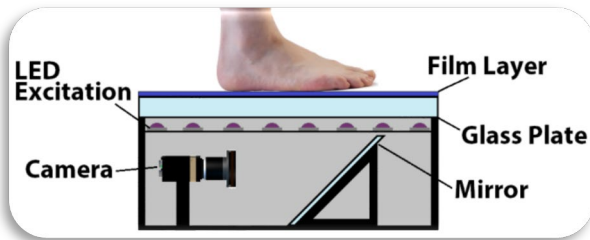
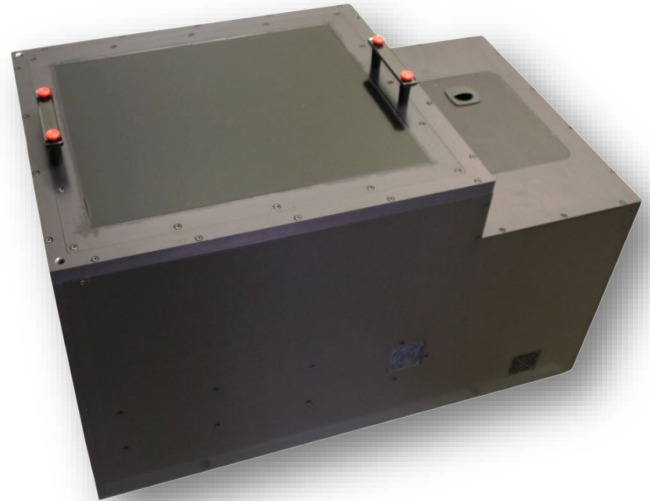

Power	110-240 VAC, 50-60 Hz
Interface	USB 3.0, USB 2.0
Linear Pressure Range	15-700 kPa. Unsaturated response over 2,000 kPa.
Linear Shear Range	3 to ± 100 kPa. Also not the saturation point.
Accuracy	$\pm 5\%$ of full scale for both pressure and shear
Data Capture Rate	50 fps
Spatial Resolution	2 mm
Crosstalk	Less than 3% between pressure and shear
Active Measurement Area	32 cm x 43 cm (12.6 in x 17 in)
Data Streams	Synchronized using force plate SYNC signal
Size	91.4 cm (L) by 53.3 cm (W) by 54.9 cm (H) (36 in by 21 in by 21.6 in) not including force plate.
Weight	138 kg (305 lb)
ECCN	EAR99

9 | Ordering

For customers inside the United States, please contact our sales department at issi-sales@innssi.com.

ISSI accepts major credit cards. Please note that credit card fees apply.



Outside of the U.S., ISSI has distributors in several countries. To purchase ISSI products in these countries, contact your local distributor.

ISSI Distributors

Europe

Aircraft Research Association

Manton Lane, Bedford, England MK41 7PF

Tel: +44 (0) 1234 350681

Fax: +44 (0) 1234 328584

www.ara.co.uk

pssales@ara.co.uk

ARA

China

Shanghai Bojun M&E Technology Development Co., Ltd.

Room 210

No. 951, Shilong Road,

Shanghai, China, 200237

Tel: +86 (0) 21 80392730

<http://www.shbojun.com/>

Mr. Xie Jue: 13636322354@163.com

BOJUN
上海博军

India

Sensol Technologies Pvt. Ltd.

#S/1735/D, 1st E Main Road, 4th Cross, 2nd Stage,

D - Block, Rajajinagar, Bangalore – 560010, India

Phone: +91 80-41649171

Fax: +91 80-41649730

www.sensol-india.com

Mr. Rajan Kumar: rajan@sensol-india.com

SenSol
INC.

Japan

Seika Digital Image Corporation

Measuring Systems Group
Taku-Akasaka Building
4-9-6, Akasaka, Minato-ku, Tokyo
107-0052 Japan
Tel: +81-3-3405-1288
Fax: +81-3-3405-1282

<http://www.seika-di.com/>

Mr. Masashi Yasuki: yasuki@seika-di.com

Seika Digital Image

西華デジタルイメージ株式会社

South Korea

JungJin Pressure Systems

#1024 Orange Zone ITECO
Jojeong-Daero, 150
Hanam City, Gyeonggi-Do, Korea
Tel: 82-31-790-4090~1
Fax: 82-31-790-4093

www.ipressure.co.kr/

Mr. Jong-Uk Lee: jjsys@jungjinsystem.com



Turkey

Star Teknik Elektronik Cihazlar San.ve Tic. Ltd. Sti

Barbaros Mh. Başkan Sk. No: 23 /1-2
34662 Üsküdar / Istanbul
Tel: 0090 216 651 07 00
Fax: (0216) 651 07 14

<http://www.starteknik.net/>

Sales: info@starteknik.com.tr

